

BIDS AND AWARDS COMMITTEE

INVITATION TO BID

SUPPLY, DELIVERY AND REFURBISHING OF METAL AND WOODEN SIGNAGE STAND

The Philippine International Convention Center (PICC), through its Approved Budget for CY 2019, intends to apply the sum of **EIGHT HUNDRED NINETY-TWO THOUSAND THREE HUNDRED FORTY PESOS (P892,340.00), VAT inclusive**, being the total Approved Budget for the Contract (ABC) of the aforesaid requirement consisting of two (2) lots. Bids received in excess of the ABC shall be automatically rejected at bid opening.

DESCRIPTION	ABC
Lot I – Supply and Delivery of Small and Big Metal Signage Stand	P297,000.00
Lot II – Supply of Labor and Materials for the Refurbishing of Small and Big Metal L and Wooden Signage Stands	P595,340.00

The PICC now invites bids for the procurement of the abovementioned requirement. Delivery shall be within sixty (60) calendar days for Lot I and Lot II. Bidders should have completed, within the last three (3) years from the date of submission and receipt of bids, a contract similar to the project, whose value must be at least fifty percent (50%) of the ABC. The description of an eligible bidder is contained in the Bidding Documents, particularly, in Section II – Instruction to Bidders.

Bidding will be conducted through open competitive bidding procedures, using a non-discretionary “Pass/Fail” criterion as specified in the 2016 Revised Implementing Rules and Regulations (RIRR) of Republic Act (RA) 9184, otherwise known as the “Government Procurement Reform Act”. Bidding is open to all interested bidders, subject to the conditions for eligibility as provided in the RIRR of RA 9184. Interested bidders may obtain further information from the PICC-BAC and inspect the Bidding Documents at the address given below during office hours.

A complete set of Bidding Documents may be acquired by interested Bidders from March 25, 2019 to on or before 10:00 a.m. of April 25, 2019, at the address stated below, upon payment in cash of a non-refundable fee pursuant to the latest guidelines issued by the GPPB, in the following amount of:

Description	Cost of Bidding Documents
Lot I – Supply and Delivery of Metal Signage Stand	P500.00
Lot II – Supply of Labor and Materials for the Refurbishing of Small and Big Metal L and Wooden Signage	P800.00

It may also be downloaded free of charge from the website of the Philippine Government Electronic Procurement System (Phil-GEPS) and PICC website, <https://www.picc.gov.ph>, provided that participating Bidders shall pay the applicable fee for the Bidding Documents.

The PICC-BAC will hold a Pre-Bid Conference on **April 5, 2019 at 11:00 a.m.**, at the PICC BAC Conference Room, Ground Floor, Delegation Building, which shall be open to prospective bidders. Bids must be duly received by the BAC Secretariat at the address specified below on or before 10:00 am. of April 25, 2019. Bids must be accompanied by a bid security in any of the acceptable forms and in the amount stated in ITB Clause 18.

Bid opening shall be conducted on **April 25, 2019, at 10:00 a.m.** at the PICC BAC Conference Room, Ground Floor, Delegation Building, PICC. Bids will be opened in the presence of the bidders' representatives who choose to attend. Late bids shall not be accepted.

In case the Pre-bid Conference, the deadline for the submission of Bid Documents and the opening of bids fall on a non-working day, legal holiday or special non-working holiday, the activity involved shall be moved to 2:00 p.m. of the next working day.

The PICC reserves the right to reject any and all bids, declare a failure of bidding, or not award the contract at any time prior to contract award in accordance with Section 41 of RA 9184 and its IRR, without thereby incurring any liability to the affected bidder or bidders.

For further information, please refer to:

BIDS AND AWARDS COMMITTEE (BAC)
PHILIPPINE INTERNATIONAL CONVENTION CENTER
PICC Complex, 1307 Pasay City
7894758, 7894759 and 7894760
Telefax No. 7894761

MELPIN A. GONZAGA
Chairman

Section III. Bid Data Sheet

Bid Data Sheet

ITB Clause	
1.1	The Procuring Entity is PHILIPPINE INTERNATIONAL CONVENTION CENTER (PICC)
1.1	The lot(s) and reference is/are: SUPPLY, DELIVERY AND REFURBISHING OF METAL AND WOODEN SIGNAGE STAND
2	The Funding Source is: PICC APPROVED BUDGET FOR CY 2019
3.1	No further instructions.
5.1	Eligible Bidders The following persons shall be eligible to participate in this bidding: a. Duly licensed Filipino citizens/sole proprietorships; b. Partnerships duly organized under the laws of the Philippines and of which at least sixty percent (60%) of the interest belongs to citizens of the Philippines; c. Corporations duly organized under the laws of the Philippines, and of which at least sixty percent (60%) of the outstanding capital stock belongs to citizens of the Philippines; and d. Cooperative duly organized under the laws of the Philippines, and of which at least sixty percent (60%) interest belongs to citizens of the Philippines.
5.2	Foreign bidders, except those falling under ITB Clause 5.2(b), may not participate in this procurement.
5.4	The Bidder must have completed within the last three (3) years a single contract that is similar to this requirement, the amount of which shall be at least fifty percent (50%) of the ABC. If the bidder submit bids for two (2) lots, the lot with the largest ABC shall be the basis for determining compliance with the required percentage. For this purpose, similar contract shall refer to manufacturing, fabrication and refurbishing of metal and wooden signage stands.
7	No further instructions.
8.1	Subcontracting is not allowed.
8.2	Not applicable.
9.1	The PICC will hold a pre-bid conference on _____, 2019 at ____:00 a.m.
10.1	The Procuring Entity's address is: Philippine International Convention Center PICC Complex, 1307 Pasay City BAC Secretariat Tel. No. 7894759; Telefax: 7894761



12.1(a)	No further instructions.						
12.1(a)(ii)	The bidder's SLCC similar to the contract to be bid should have been completed within three (3) years prior to the deadline for submission and receipt of bids. The SLCC shall be supported with certified photocopy of its Contract and Certificate of Completion and Acceptance or Official Receipt /Sales Invoice issued for the contract.						
13.1	No additional requirements.						
13.1(b)	No further instructions.						
13.1(c)	No additional requirements.						
13.2	<p>The Total ABC is of EIGHT HUNDRED NINETY-TWO THOUSAND THREE HUNDRED FORTY PESOS (P892,340.00), VAT Inclusive.</p> <table border="1" data-bbox="429 831 1284 1120"> <thead> <tr> <th>DESCRIPTION</th> <th>ABC</th> </tr> </thead> <tbody> <tr> <td>Lot I – Supply and Delivery of Small and Big Metal Signage Stand</td> <td>P297,000.00</td> </tr> <tr> <td>Lot II – Supply of Labor and Materials for the Refurbishing of Small and Big Metal L and Wooden Signage Stands</td> <td>P595,340.00</td> </tr> </tbody> </table> <p>Any bid with a financial component exceeding this amount per lot shall not be accepted.</p>	DESCRIPTION	ABC	Lot I – Supply and Delivery of Small and Big Metal Signage Stand	P297,000.00	Lot II – Supply of Labor and Materials for the Refurbishing of Small and Big Metal L and Wooden Signage Stands	P595,340.00
DESCRIPTION	ABC						
Lot I – Supply and Delivery of Small and Big Metal Signage Stand	P297,000.00						
Lot II – Supply of Labor and Materials for the Refurbishing of Small and Big Metal L and Wooden Signage Stands	P595,340.00						
15.4 (a)(iv)	No incidental services are required.						
15.4 (b)	No incidental services are required.						
16.1 (b)	<p>Bid Currencies</p> <p>The bid prices shall be quoted in Philippine Pesos.</p>						
16.3	Payment shall be made in Philippine Pesos.						
17.1	<p>Bid Validity Period</p> <p>Bids will be valid for one hundred twenty (120) calendar days from the date of opening of bids.</p>						
18.1	<p>The bid security shall be;</p> <ul style="list-style-type: none"> • Notarized Bid Securing Declaration; or • Cash or Cashier's/Manager's check (confirmed by universal or commercial bank), in an amount equivalent to 2% of the ABC; or • Bank draft/guarantee issued by a Universal or Commercial Bank in the amount of 2% of the ABC; or • Surety Bond, callable upon demand and issued by a surety or insurance company in the amount of not less than 5% of the 						

	ABC, with attached certification issued by the Office of the Insurance Commission that said insurance company is authorized to issue such security;
18.2	The bid security shall be valid one hundred twenty (120) calendar days from the date of opening of bids.
20.3	Sealing and Marking of Bids Each Bidder shall submit One (1) original copy and two (2) duplicate copies of the Eligibility documents and the Financial Bid Proposal signed by the bidder and/or the authorized representative. (See Annex "F")
21	The address for submission of bids is: PICC-Bids and Awards Committee (BAC) Secretariat Ground Floor, Delegation Building PICC Complex, 1307 Pasay City The deadline for submission of bids is April 25, 2019 at 10:00 a.m.
24.1	The place of bid opening is: BAC CONFERENCE ROOM Ground Floor, Delegation Building PICC Complex, 1307 Pasay City The date and time of bid opening is April 25, 2019 at 10:00 a.m. In case the Bids cannot be opened as scheduled due to justifiable reasons, the BAC shall take custody of the Bids submitted and the opening of Bids shall be at 2:00 p.m. of the next working day.
24.2	No further instructions.
24.3	No further instructions.
27.1	No further instructions.
28.3(a)	Partial bids are allowed. All Goods are grouped in lots listed below: Lot I – Supply and Delivery of Small and Big Metal Signage Stand Lot II – Supply of Labor and Materials for the Refurbishing of Small and Big Metal L and Wooden Signage Stands Bidders shall have the option of submitting a proposal for any or all lots and evaluation and contract award will be undertaken on a per lot basis. Lots shall not be divided further into sub-lots for the purpose of bidding, evaluation and contract award. In all cases, the NFCC computation must be sufficient for all the lots or contracts to be awarded to the Bidder.
28.4	No further instructions.

29.2	<p>Post-Qualification</p> <p>Within a non-extendible period of five (5) calendar days from receipt by the bidder of the notice from the BAC that it submitted the LCB, the Bidder shall submit the following documentary requirements:</p> <ul style="list-style-type: none"> a. Certified Photocopy of the CY 2017 Income and Business Tax Returns filed and paid through the BIR Electronic Filing and Payment System (eFPS); b. Sections III and V of the bid documents, signed on each and every page by the bidder's authorized representative; c. Company Profile with sketch of office location; d. Certificate of Satisfactory Completion & Acceptance of previous PICC undertaken within the last three (3) years, any. <p>Failure of the bidder with the lowest calculated bid to submit the above requirements, or a finding against the veracity of such requirements shall be ground for forfeiture of the bid security and disqualification of the bidder for award.</p>
32.4 (f)	No additional requirement.

g/g/h

Section V. Special Conditions of Contract

Special Conditions of Contract

GCC Clause	
1.1(g)	The Procuring Entity is <i>The Philippine International Convention Center (PICC)</i>
1.1(i)	The Supplier is <i>[to be inserted at the time of contract award]</i> .
1.1(j)	The Funding Source is PICC APPROVED BUDGET FOR CY 2019
1.1(k)	The Project Site is <i>PICC, PICC Complex, 1307 Pasay City</i>
2.1	No further instructions.
5.1	The PICC's address for Notices is: PICC-Bids and Awards Committee PICC Complex, 1307 Pasay City
6.1	Delivery of the Goods shall be made by the Supplier in accordance with the terms specified in Section VI – Schedule of Requirements Upon delivery of the Goods, the Supplier shall present the following documents: (i) Original and four copies of the Supplier's invoice showing Goods' description, quantity, unit price, and total amount; (ii) Original and four copies delivery receipt/note detailing number and description of items received signed by the authorized receiving personnel; For purposes of this Clause the Authorized Representative of PICC is Ms. Elizabeth B. Aguila, Asst. Director, MEMD.
10.4	Payment shall be made in Philippine Pesos.
10.5	Payment using LC is not allowed.
11.3	Payment Full payment shall be made after complete delivery and acceptance of the items and submission of the Sales Invoice. Five percent (5%) of the payment shall be retained to cover the warranty obligations.
13.4(c)	Performance Security Within ten (10) calendar days from receipt of the Notice of Award, but in no case later than the signing of the contract by both parties, the successful Bidder shall furnish the performance security in any of the following forms:

	<table border="1"> <tr> <td>Form of Performance Security</td> <td>Amount of Performance Security (Equal to Percentage of the Total Contract Price)</td> </tr> <tr> <td>Cash or Cashier's/Manager's Check issued by a Universal or Commercial Bank.</td> <td>Five percent (5%)</td> </tr> <tr> <td>Bank draft/guarantee issued by a Universal or Commercial Bank</td> <td>Five percent (5%)</td> </tr> <tr> <td>Surety bond callable upon demand issued by a surety or insurance company duly certified by the Insurance Commission as authorized to issue such security.</td> <td>Thirty percent (30%)</td> </tr> </table>	Form of Performance Security	Amount of Performance Security (Equal to Percentage of the Total Contract Price)	Cash or Cashier's/Manager's Check issued by a Universal or Commercial Bank.	Five percent (5%)	Bank draft/guarantee issued by a Universal or Commercial Bank	Five percent (5%)	Surety bond callable upon demand issued by a surety or insurance company duly certified by the Insurance Commission as authorized to issue such security.	Thirty percent (30%)
Form of Performance Security	Amount of Performance Security (Equal to Percentage of the Total Contract Price)								
Cash or Cashier's/Manager's Check issued by a Universal or Commercial Bank.	Five percent (5%)								
Bank draft/guarantee issued by a Universal or Commercial Bank	Five percent (5%)								
Surety bond callable upon demand issued by a surety or insurance company duly certified by the Insurance Commission as authorized to issue such security.	Thirty percent (30%)								
16.1	<p>Inspection and Tests</p> <p>PICC may reject any materials that do not conform to the specifications. The Contractor shall replace such materials to meet the specifications at no cost to PICC.</p>								
17.3	<p>Warranty period:</p> <table border="1"> <thead> <tr> <th>Description</th> <th>Warranty Period</th> </tr> </thead> <tbody> <tr> <td>Lot I – Supply and Delivery of Small and Big Metal Signage Stand</td> <td>Three (3) months</td> </tr> <tr> <td>Lot II – Supply of Labor and Materials for the Refurbishing of Small and Big Metal L and Wooden Signage Stands</td> <td>Three (3) months</td> </tr> </tbody> </table> <p>The obligation for the warranty shall be covered by either retention money in an amount equivalent to five percent (5%) of the total contract price, or a special bank guarantee & equivalent to five percent (5%) of the total contract price. (Note: GPPB RES NO. 30-20170).</p> <p>The said amount shall be released after the lapse of the warranty period or after consumption thereof, provided, that the supplies delivered are free from patent and latent defects and all the conditions imposed under the contract have been fully met.</p>	Description	Warranty Period	Lot I – Supply and Delivery of Small and Big Metal Signage Stand	Three (3) months	Lot II – Supply of Labor and Materials for the Refurbishing of Small and Big Metal L and Wooden Signage Stands	Three (3) months		
Description	Warranty Period								
Lot I – Supply and Delivery of Small and Big Metal Signage Stand	Three (3) months								
Lot II – Supply of Labor and Materials for the Refurbishing of Small and Big Metal L and Wooden Signage Stands	Three (3) months								
17.4	The period for correction of defects in the warranty period is seven (7) calendar days upon receipt of notice from PICC project-in-charge.								
21.1	No additional provision.								

Section VI. Schedule of Requirements

Section VI. Schedule of Requirements

The schedule of delivery shall be:

Description	Delivery
Lot I – Supply and Delivery of Small and Big Metal Signage Stand	<p>The completion of prototype sample of workmanship shall be within three (3) weeks after the receipt of Notice to Proceed</p> <p>The delivery shall be within ninety (90) calendar days after the receipt of approved prototype.</p>
Lot II – Supply of Labor and Materials for the Refurbishing of Small and Big Metal L and Wooden Signage Stands	Full delivery within ninety (90) calendar days after the receipt of Notice to Proceed



I hereby commit to comply and deliver all the above requirements in accordance with the above stated schedule.

Name of Company / Bidder

Signature over printed Name of Authorized Representative

Position

Date

Section VII. Technical Specifications

Section VII. Technical Specifications

Item No.	Qty.	Unit	Article /Description	COMPLIANCE
Lot I – Supply and Delivery of Small and Big Metal Signage Stand				
1	20	pieces	<p>SMALL METAL SIGNAGE STAND</p> <p>Specifications:</p> <ul style="list-style-type: none"> • Size: 14" x 9 ¾" signage frame; with adjustable height post and 12" diameter metal base all made of stainless metal in hairline finish. • With 2 acrylic sheets for the 8 ½" x 13" signage/poster • With screws for lock • With rubberized protection underneath the metal base • See actual sample for other specifications • Must submit a sample of finished product for approval by the end-user within three (3) weeks after the receipt of Notice to Proceed <p><i>See attached photo and shop drawing</i></p>	
2	10	pieces	<p>BIG METAL SIGNAGE STAND</p> <p>Specifications:</p> <ul style="list-style-type: none"> • Size: 24" x 36" (signage frame,) x 72" high (overall) • 2" diameter post and 14" metal base all made of stainless steel metal in hairline finish, heavy weight enough to carry the weight of the post and signage frame, with rubberized protection underneath; • With 2 pcs 3/32" thick acrylic sheets for the 24" x 36" signage/postage with 0.020 styrene to allow a paper graphic to fit • With screws for lock, with allen key • With universal ring that accept swag ropes from any direction • Must submit a sample of finished product for approval by the end-user within three (3) weeks after the receipt of Notice to Proceed <p><i>See attached drawing</i></p>	
Lot II – Supply of Labor and Materials for the Refurbishing of Small and Big Metal L and Wooden Signage Stands				
1	42	pieces	<p>SMALL METAL SIGNAGE STAND</p> <p>Scope of Works</p> <ul style="list-style-type: none"> - Size: 14" x 9 ¾" signage frame, with adjustable height - Replacement/repair of worn out stainless steel parts - Re-buffing of exposed stainless steel parts - Repair/Replacement of the loose thread for the adjustable height mechanism, with lock - Replacement of acrylic sheets (2 pcs/unit 	

[Handwritten Signature]

2	40	pieces	<p>BIG METAL SIGNAGE STAND</p> <p>Scope of Works</p> <ul style="list-style-type: none"> - Size: 14" x 22" signage frame x 40 ½" high post - Replacement/repair of worn out stainless steel parts including screws - Re-buffing of exposed stainless steel parts - Replacement of acrylic sheets (2 pcs/unit)
3	20	pieces	<p>WOODEN SIGNAGE STAND</p> <p>Scope of Works</p> <ul style="list-style-type: none"> - Size: 66" x 30" - Repair/Replacement of worn out wooden parts specify (see actual condition) - Re-finishing in semi-gloss lacquer finish (same as existing) - Removal of flexiglass sheet
<p style="text-align: center;">Statement of Compliance</p> <p>Bidders must state here either "Comply" or "Not Comply" against each of the individual parameters of each Specification stating the corresponding performance parameter of the equipment offered.</p>			

Handwritten initials/signature

Lot I - Supply and Delivery of Small and Big Metal Signage Stands

<https://mail.google.com/mail/u/0/#inbox/FMfcgxwBTkgTQTQDs...>

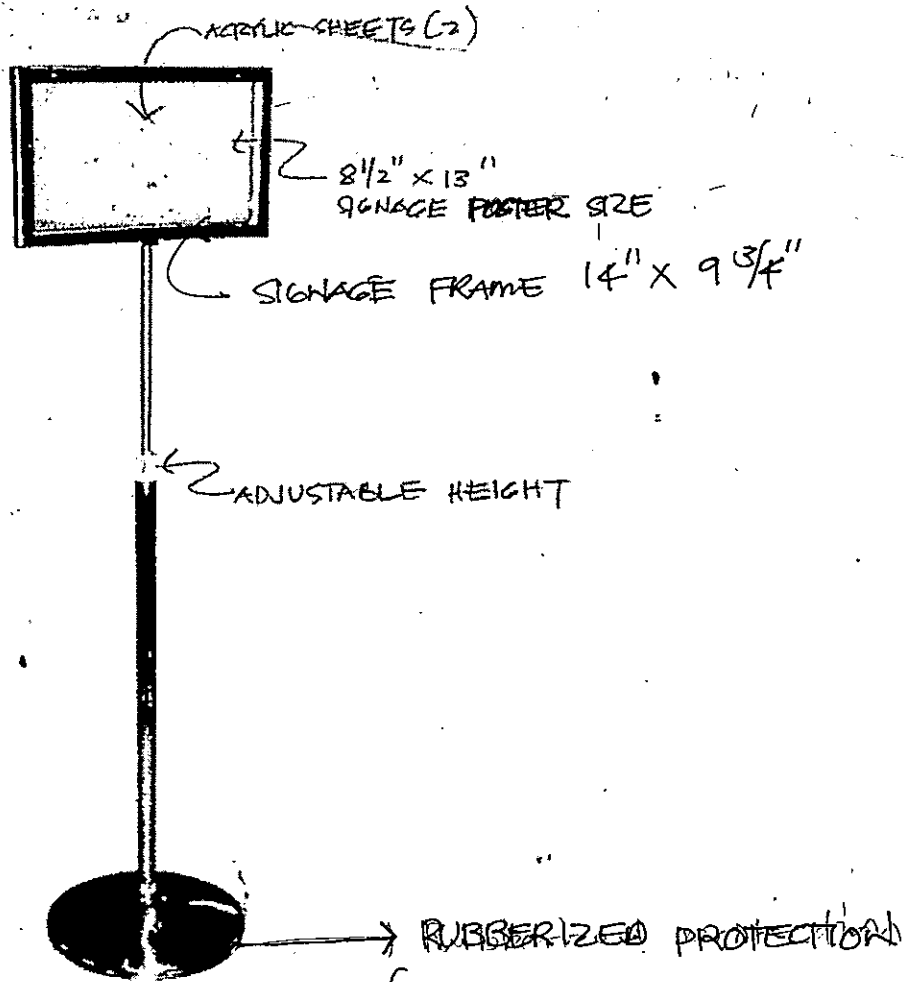

SMALL METAL SIGNAGE STAND

(SEE SHOP DRAWING)

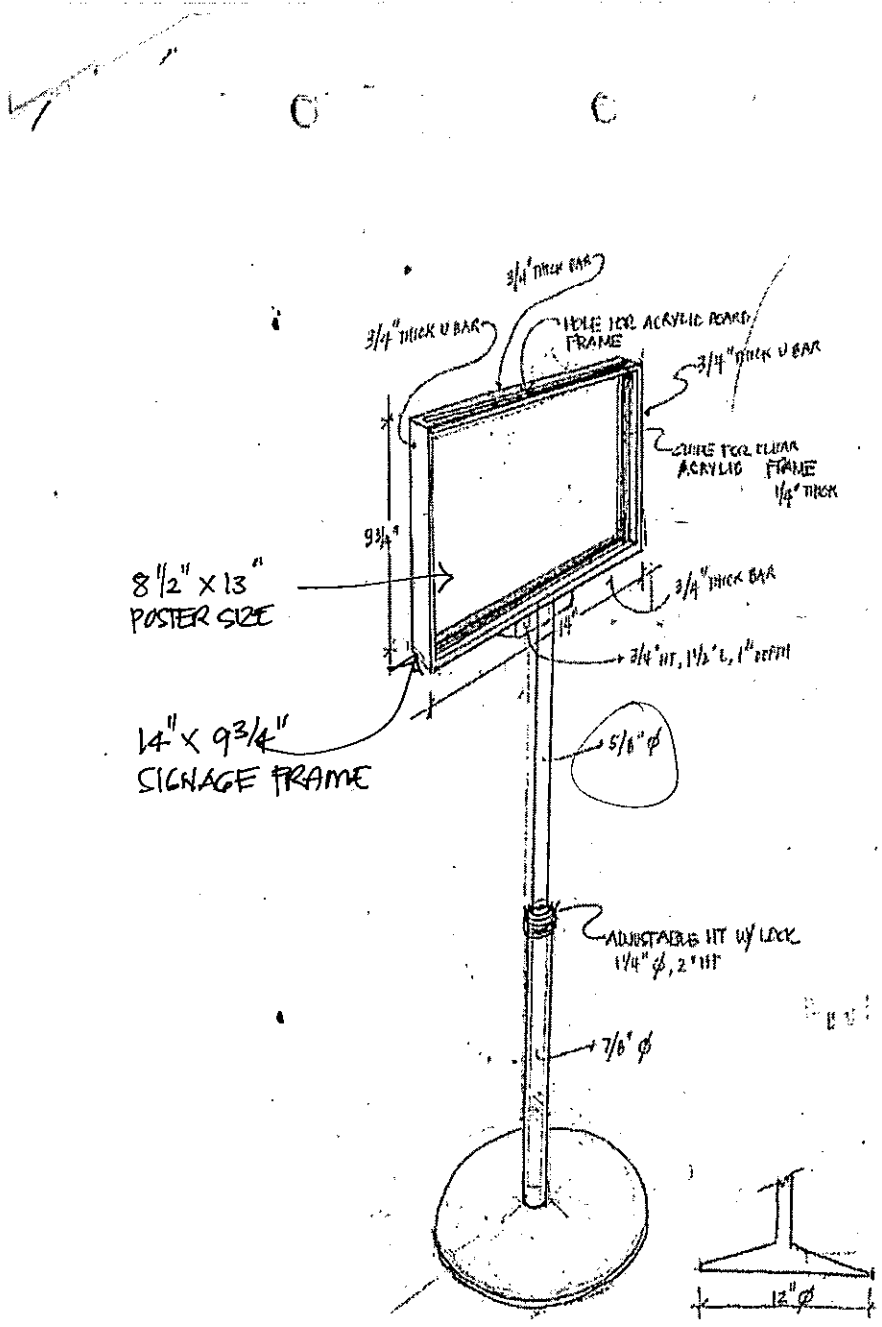

○ SIGN STAND (STAINLESS)
 HEIGHT: MINIMUM OF 3 1/2 FT MAXIMUM OF 6 FT (8 FT HT)
 (STOP DRAWING)

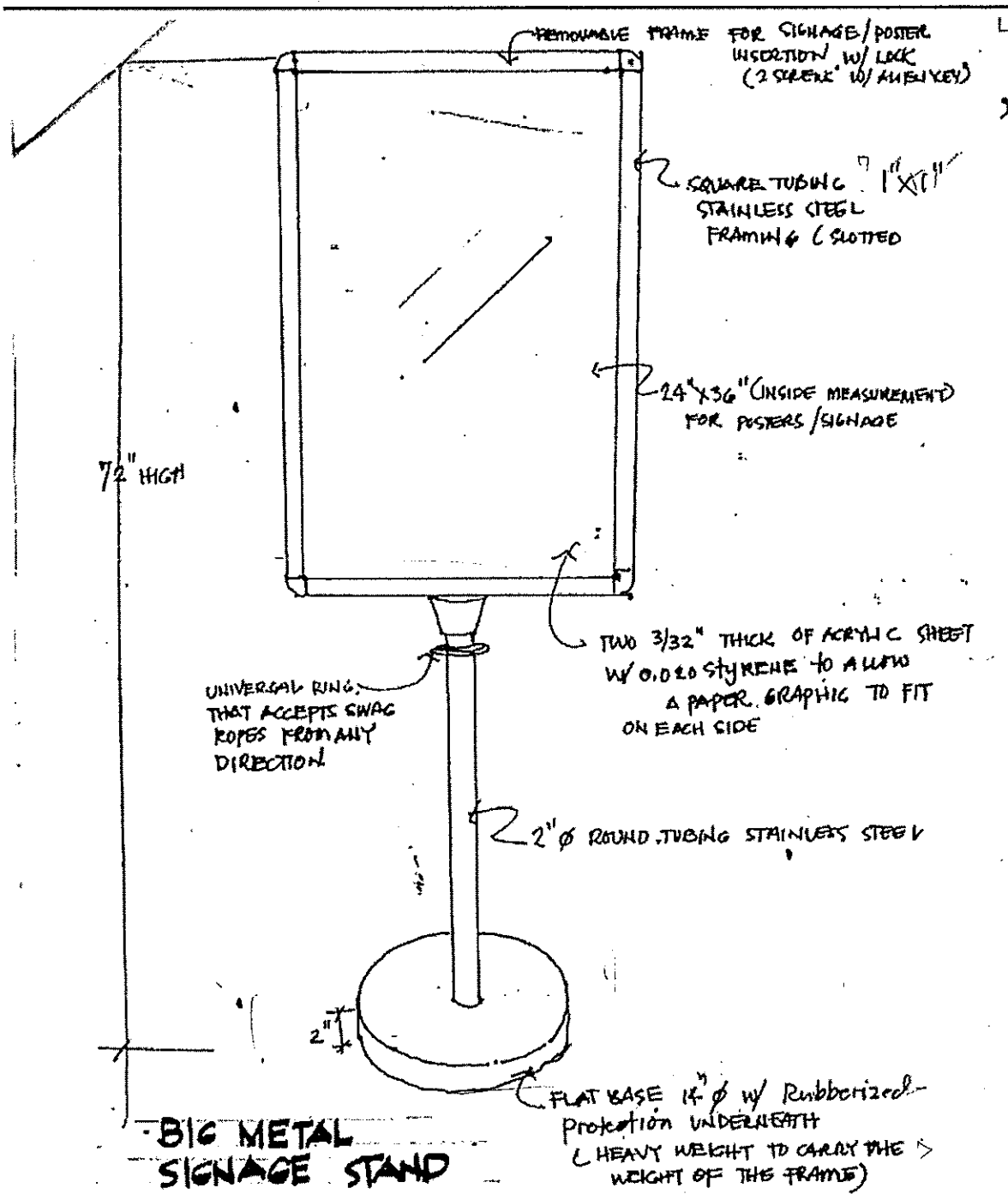

LOT II – Supply of Labor and Materials for the Refurbishing of Small and Big Metal Stands and Wooden Signage Stands

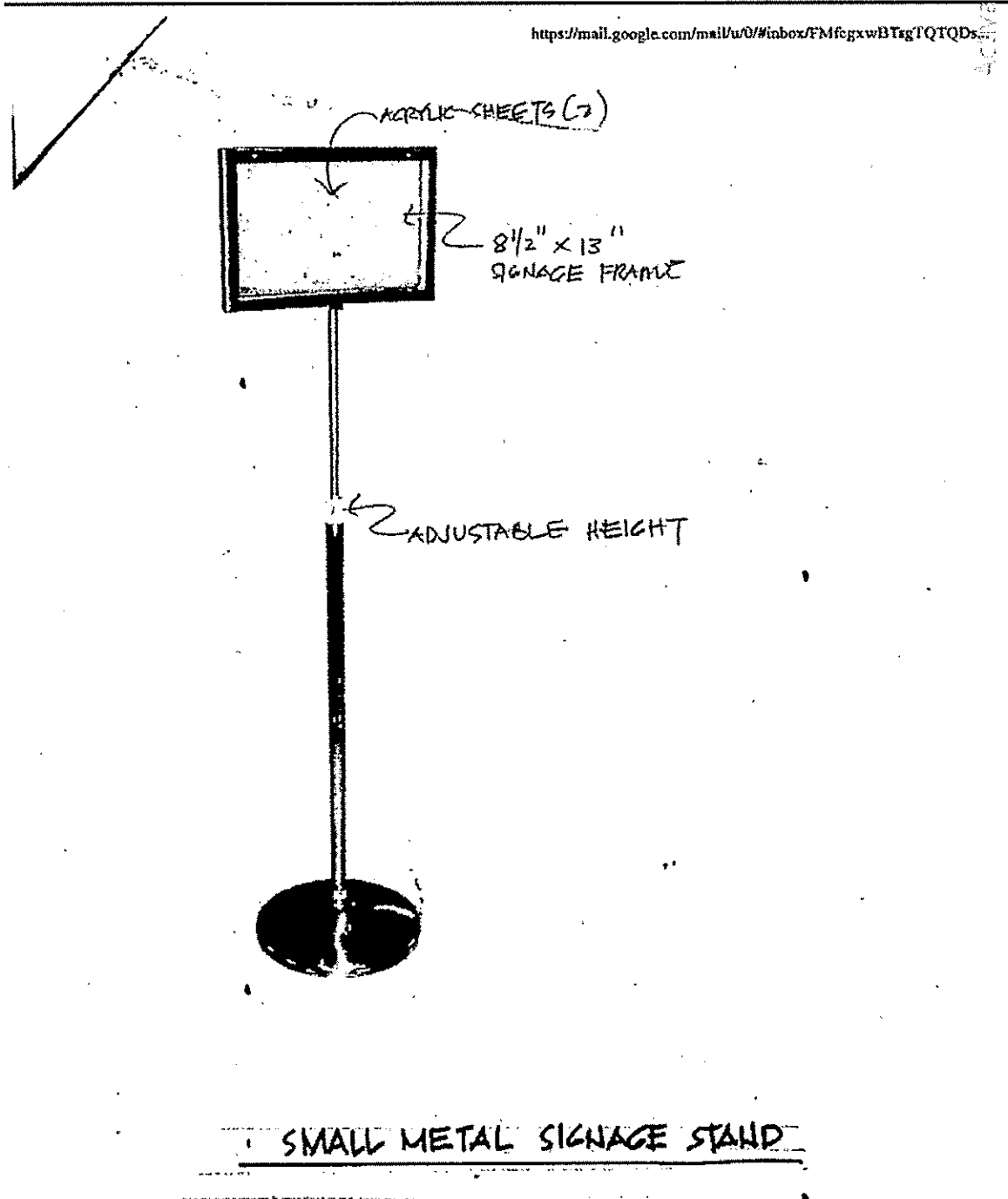

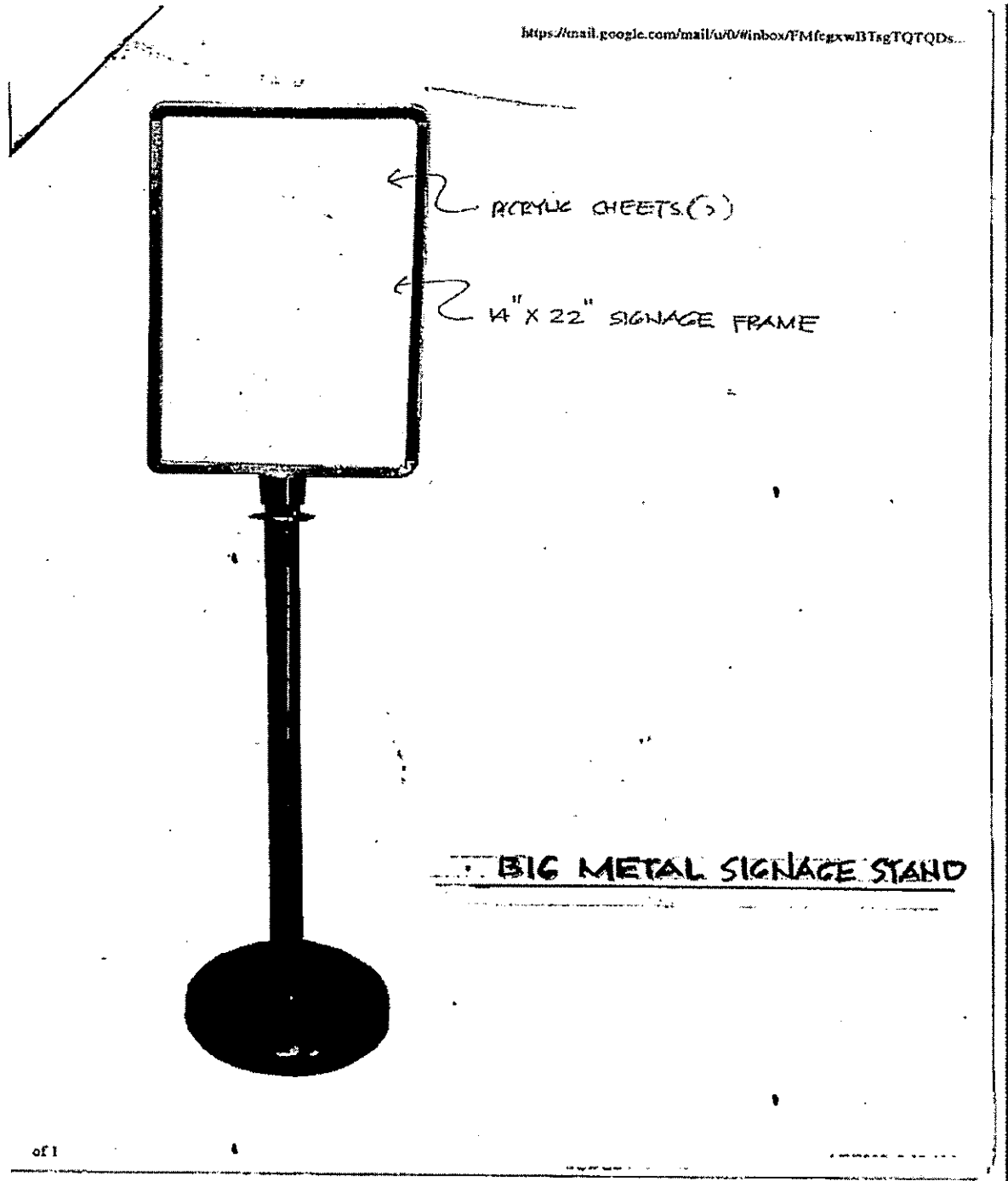

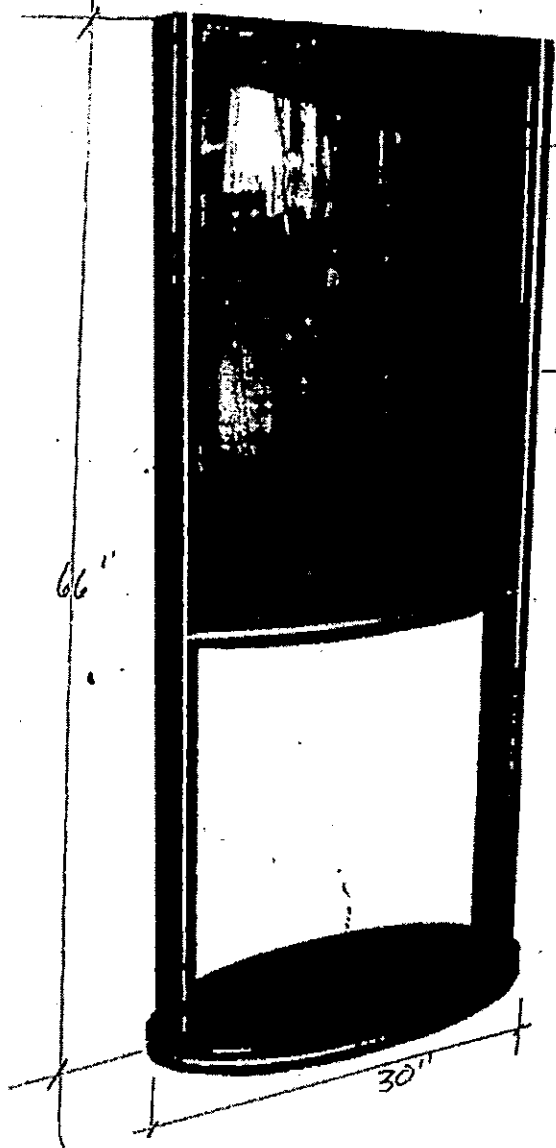

FLEXIGLASS COVER

24" X 36" SIGNAGE FRAME

WOODEN SIGNAGE STAND

Section VIII. Bidding Forms

Section VIII. Bidding Forms

Bid Form

Date: _____

To: *[name and address of Procuring Entity]*

Gentlemen and/or Ladies:

Having examined the Bidding Documents including Bid Bulletin Numbers *[insert numbers]*, the receipt of which is hereby duly acknowledged, we, the undersigned, offer to the goods below stated in conformity with the said Bidding Documents for the sum/s as follows:

Description	Amount of Bid/s in words and figures (VAT Inclusive)
Lot I – Supply and Delivery of Small and Big Metal Signage Stand	
1. SMALL METAL SIGNAGE STAND	TOTAL AMOUNT OF BIDS IN WORDS
	____ (P_____) VAT Inclusive
2. BIG METAL SIGNAGE STAND	TOTAL AMOUNT OF BIDS IN WORDS
	____ (P_____) VAT Inclusive
TOTAL AMOUNT	TOTAL AMOUNT OF BIDS IN WORDS
	____ (P_____) VAT Inclusive
Lot II – Supply of Labor and Materials for the Refurbishing of Small and Big Metal Stands and Wooden Signage Stands	
1. SMALL METAL SIGNAGE STAND	TOTAL AMOUNT OF BIDS IN WORDS
	(P_____) VAT Inclusive
2. BIG METAL SIGNAGE STAND	TOTAL AMOUNT OF BIDS IN WORDS
	(P_____) VAT Inclusive

3. WOODEN SIGNAGE STANDS	TOTAL AMOUNT OF BIDS IN WORDS
	(P _____) VAT Inclusive
TOTAL AMOUNT	TOTAL AMOUNT OF BIDS IN WORDS
	(P _____) VAT Inclusive

We undertake, if our Bid is accepted, to deliver the goods in accordance with the delivery schedule specified in the Schedule of Requirements.

If our Bid is accepted, we undertake to provide a performance security in the form, amounts, and within the times specified in the Bidding Documents.

We agree to abide by this Bid for the Bid Validity Period specified in **BDS** provision for **ITB** Clause 17.1 and it shall remain binding upon us and may be accepted at any time before the expiration of that period.

Until a formal Contract is prepared and executed, this Bid, together with your written acceptance thereof and your Notice of Award, shall be binding upon us.

We understand that you are not bound to accept the lowest or any Bid you may receive.

We certify/confirm that we comply with the eligibility requirements as per **ITB** Clause 5 of the Bidding Documents.

We likewise certify/confirm that the undersigned, *[for sole proprietorships, insert: as the owner and sole proprietor or authorized representative of Name of Bidder, has the full power and authority to participate, submit the bid, and to sign and execute the ensuing contract, on the latter's behalf for the Supply, Delivery and Refurbishing of Metal and Wooden Signage Stands of the Philippine International Convention Center [for partnerships, corporations, cooperatives, or joint ventures, insert: is granted full power and authority by the Name of Bidder, to participate, submit the bid, and to sign and execute the ensuing contract on the latter's behalf for Supply, Delivery and Refurbishing of Metal and Wooden Signage Stands of the Philippine International Convention Center.*

We acknowledge that failure to sign each and every page of this Bid Form, including the attached Schedule of Prices, shall be a ground for the rejection of our bid.

Dated this _____ day of _____ 2019.

[signature]

[in the capacity of]

Duly authorized to sign Bid for and on behalf of _____

PHILIPPINE INTERNATIONAL CONVENTION CENTER
BIDS AND AWARDS COMMITTEE

CHECKLIST OF REQUIREMENTS

Bidders shall submit their bids through their duly authorized representative using the forms specified in the Bidding Documents in **two (2) separate sealed bid envelopes**, and which shall be submitted simultaneously. The first envelope shall contain the technical component of the bid including the eligibility requirements and the second shall contain the financial component of the bid.

I. FIRST ENVELOPE: ELIGIBILITY AND TECHNICAL COMPONENTS;

A. ELIGIBILITY DOCUMENTS:

1. Certified photocopy of the valid and current PhilGEPS Certificate of Registration – Platinum Membership. The certificate shall be submitted together with Annex "A".

IF any of the documents mentioned in Annex "A" has expired, the new document should be submitted.

2. Statement of all on-going government and private contracts, including contracts awarded but not yet started, if any, whether similar or not similar in nature and complexity to the contract to be bid (**ANNEX "A"**);
3. Statement of the Single Largest Completed Contract (SLCC) similar to the contract to be bid, entered into within the last three (3) years from the date of submission and opening of bids, and whose value is at least fifty percent (50%) of the ABC. (**ANNEX "B"**) Attach to such statement the following:
 - a. Certified photocopy of the SLCC; and
 - b. Certificate of Completion and Acceptance or Official Receipt/s or sales invoice issued for the contract.
4. Net Financial Contracting Capacity (NFCC): (**ANNEX "C"**)

Computation of NFCC must be at least equal to the ABC to be bid, calculated as follows;

NFCC = [(Current assets minus current liabilities)(15)] minus the value of all outstanding or uncompleted portions of the projects under ongoing contracts, including awarded contracts yet to be started, coinciding with the contract to be bid.

or a committed Line of Credit from Universal or Commercial Bank, in lieu of its NFCC Computation. The committed Line of Credit must be at least equal to ten percent (10%) of the ABC to be bid.

B. TECHNICAL COMPONENT:

1. Bid Security:

- Notarized Bid Securing Declaration (**ANNEX "D"**); or
- Cash or Manager's Check / Cashier's check issued by a Universal or Commercial Bank in the amount of not less than 2% of the ABC; or
- Bank draft/guarantee or irrevocable letter of credit issued by a Universal or Commercial Bank in the amount of not less than 2% of the ABC; or
- Surety Bond, callable upon demand, issued by a private insurance company with attached Certification issued by the Office of the Insurance Commission that said insurance company is authorized to issue such surety, in the amount of not less than 5% of the ABC.

2. Sections VI – Schedule of requirements and VII- Technical Specifications of the Bidding Documents, fully accomplished;

3. Notarized Omnibus Sworn Statement (**ANNEX "E"**) with attached;

- a. For Corporations, the duly notarized Secretary's Certificate; or
- b. For Sole Proprietorship, the notarized Special Power of Attorney.

II. SECOND ENVELOPE: FINANCIAL COMPONENT OF THE BID (BID PROPOSAL FORMS)

1. Financial Bid Form (Section VIII of the Bidding Documents);

Standard Form Number : SF-GOOD-13a

Revised on: July 28, 2004

LIST OF ALL ON-GOING GOVERNMENT & PRIVATE CONTRACTS INCLUDING CONTRACTS AWARDED BUT NOT YET STARTED

Business Name:

Business Address:

Name of Project / Project Cost	a. Owner's Name b. Address c. Telephone Nos.	Nature of Work	Bidder's Role		a. Date Awarded b. Date Started c. Date Completion	% of Accomplishment		Value of Outstanding Works / Undelivered Portion
			Description	%		Planned	Actual	
Government:								
Private:								

Submitted by:

(Printed Name & Signature)

Designation:

Date:

**SINGLE LARGEST COMPLETED CONTRACT
WHICH IS SIMILAR TO THE CONTRACT TO BE BID**

Business Name: _____
Business Address: _____

Name of Contract	a. Owner' Name b. Address c. Telephone Nos.	Nature of Item/Service	a. Amount of Award b. Amount at Completion c. Duration	a. Date Awarded b. Contract Effectivity c. Date Completed

Note: This statement shall be supported with:

1. Contract
2. Certificate of Completion and Acceptance or Official Receipt/s or Sales Invoice issued for the contract

Note: The Single Largest Completed Contract shall be completed within the last three (3) years from the date of submission and receipt of bids, that is similar to the contract to be bid, the amount of which shall be at least fifty percent (50%) of the ABC

Submitted by: _____

(Printed Name & Signature)

Designation: _____

Date: _____

ANNEX "C"

Name of the Procuring Entity

Project Reference Number

Name of the Project

Location of the Project

Standard Form Number: SF-GOOD-14

Revised on: May 24, 2004

FINANCIAL DOCUMENTS FOR ELIGIBILITY CHECK

A. Summary of the Applicant Supplier's/Distributor's/Manufacturer's assets and liabilities on the basis of the attached Income Tax Return and Audited Financial Statement, stamped "RECEIVED" by the Bureau of Internal Revenue or BIR authorized collecting agent, for the immediately preceding year and a certified copy of Schedule of Fixed Assets particularly the list of construction equipment.

		Year 20
1.	Total Assets	
2.	Current Assets	
3.	Total Liabilities	
4.	Current Liabilities	
5.	Net Worth (1-3)	
6.	Net Working Capital (2-4)	
7.	Value of all outstanding or uncompleted portions of the project under ongoing contracts, including awarded contracts yet to be started coinciding with contract to be bid.	

B. The Net Financial Contracting Capacity (NFCC) based on the above data is computed as follows:

NFCC = [(Current assets minus current liabilities) (15)] minus value of all outstanding or uncompleted portions of the project under ongoing contracts, including awarded contracts yet to be started coinciding with contract to be bid.

NFCC = P _____

The values of the bidder's current assets and current liabilities shall be based on the data submitted to the BIR.

or

A committed Line of Credit, in an amount to at least ten percent (10%) of the ABC, issued by a Universal of Commercial Bank:

Submitted by:

Name of Supplier / Distributor / Manufacturer

Signature of Authorized Representative

Date: _____

Note:

1. If Partnership or Joint Venture, each Partner or Member Firm of Joint Venture shall submit the above requirements.

BID SECURING DECLARATION FORM

REPUBLIC OF THE PHILIPPINES)
CITY OF _____) S.S.

X-----X

BID SECURING DECLARATION

Invitation to Bid: *[Insert Reference number]*

To: *[Insert name and address of the Procuring Entity]*

I/We¹, the undersigned, declare that:

1. I/We understand that, according to your conditions, bids must be supported by a Bid Security, which may be in the form of a Bid-Securing Declaration.
2. I/We accept that: (a) I/we will be automatically disqualified from bidding for any contract with any procuring entity for a period of two (2) years upon receipt of your Blacklisting order; and, (b) I/we will pay the applicable fine provided under Section 6 of the Guidelines on the Use of Bid Securing Declaration, within fifteen (15) days from receipt of the written demand by the procuring entity for the commission of acts resulting to the enforcement of the bid securing declaration under Sections 23.1(b), 34.2, 40.1 and 69.1, except 69.1(f), of the IRR of RA 9184; without prejudice to other legal action the government may undertake.
3. I/We understand that this Bid Securing Declaration shall cease to be valid on the following circumstances:
 - (a) Upon expiration of the bid validity period, or any extension thereof pursuant to your request;
 - (b) I am/we are declared ineligible or post-disqualified upon receipt of your notice to such effect, and (i) I/we failed to timely file a request for reconsideration or (ii) I/we filed a waiver to avail of said right;

¹ Select one and delete the other. Adopt the same instruction for similar terms throughout the document.

- (c) I am/we are declared the bidder with the Lowest Calculated Responsive Bid, and I/we have furnished the performance security and signed the Contract.

IN WITNESS WHEREOF, I/We have hereunto set my/our hand/s this ____ day of [month] [year] at [place of execution].

[Insert NAME OF BIDDER'S AUTHORIZED REPRESENTATIVE]

[Insert Signatory's Legal Capacity]

Affiant

SUBSCRIBED AND SWORN to before me this ____ day of [month] [year] at [place of execution], Philippines. Affiant/s is/are personally known to me and was/were identified by me through competent evidence of identity as defined in the 2004 Rules on Notarial Practice (A.M. No. 02-8-13-SC). Affiant/s exhibited to me his/her [insert type of government identification card used], with his/her photograph and signature appearing thereon, with no. _____ and his/her Community Tax Certificate No. _____ issued on ____ at _____.

Witness my hand and seal this ____ day of [month] [year].

NAME OF NOTARY PUBLIC

Serial No. of Commission _____

Notary Public for _____ until _____

Roll of Attorneys No. _____

PTR No. _____ [date issued], [place issued]

IBP No. _____ [date issued], [place issued]

Doc. No. _____

Page No. _____

Book No. _____

Series of _____

Omnibus Sworn Statement

REPUBLIC OF THE PHILIPPINES)
CITY/MUNICIPALITY OF _____) S.S.

AFFIDAVIT

I, *[Name of Affiant]*, of legal age, *[Civil Status]*, *[Nationality]*, and residing at *[Address of Affiant]*, after having been duly sworn in accordance with law, do hereby depose and state that:

1. *Select one, delete the other:*

If a sole proprietorship: I am the sole proprietor or authorized representative of *[Name of Bidder]* with office address at *[address of Bidder]*;

If a partnership, corporation, cooperative, or joint venture: I am the duly authorized and designated representative of *[Name of Bidder]* with office address at *[address of Bidder]*;

2. *Select one, delete the other:*

If a sole proprietorship: As the owner and sole proprietor, or authorized representative of *[Name of Bidder]*, I have full power and authority to do, execute and perform any and all acts necessary to participate, submit the bid, and to sign and execute the ensuing contract for *[Name of the Project]* of the *[Name of the Procuring Entity]*, as shown in the attached duly notarized *Special Power of Attorney*;

If a partnership, corporation, cooperative, or joint venture: I am granted full power and authority to do, execute and perform any and all acts necessary to participate, submit the bid, and to sign and execute the ensuing contract for *[Name of the Project]* of the *[Name of the Procuring Entity]*, as shown in the attached *[state title of attached document showing proof of authorization (e.g., duly notarized Secretary's Certificate, Board/Partnership Resolution, or Special Power of Attorney, whichever is applicable);]*;

3. *[Name of Bidder]* is not "blacklisted" or barred from bidding by the Government of the Philippines or any of its agencies, offices, corporations, or Local Government Units, foreign government/foreign or international financing institution whose blacklisting rules have been recognized by the Government Procurement Policy Board;
4. Each of the documents submitted in satisfaction of the bidding requirements is an authentic copy of the original, complete, and all statements and information provided therein are true and correct;

5. *[Name of Bidder]* is authorizing the Head of the Procuring Entity or its duly authorized representative(s) to verify all the documents submitted;

6. **Select one, delete the rest:**

If a sole proprietorship: The owner or sole proprietor is not related to the Head of the Procuring Entity, members of the Bids and Awards Committee (BAC), the Technical Working Group, and the BAC Secretariat, the head of the Project Management Office or the end-user unit, and the project consultants by consanguinity or affinity up to the third civil degree;

If a partnership or cooperative: None of the officers and members of *[Name of Bidder]* is related to the Head of the Procuring Entity, members of the Bids and Awards Committee (BAC), the Technical Working Group, and the BAC Secretariat, the head of the Project Management Office or the end-user unit, and the project consultants by consanguinity or affinity up to the third civil degree;

If a corporation or joint venture: None of the officers, directors, and controlling stockholders of *[Name of Bidder]* is related to the Head of the Procuring Entity, members of the Bids and Awards Committee (BAC), the Technical Working Group, and the BAC Secretariat, the head of the Project Management Office or the end-user unit, and the project consultants by consanguinity or affinity up to the third civil degree;

7. *[Name of Bidder]* complies with existing labor laws and standards; and

8. *[Name of Bidder]* is aware of and has undertaken the following responsibilities as a Bidder:

- a) Carefully examine all of the Bidding Documents;
- b) Acknowledge all conditions, local or otherwise, affecting the implementation of the Contract;
- c) Made an estimate of the facilities available and needed for the contract to be bid, if any; and
- d) Inquire or secure Supplemental/Bid Bulletin(s) issued for the *[Name of the Project]*.

9. *[Name of Bidder]* did not give or pay directly or indirectly, any commission, amount, fee, or any form of consideration, pecuniary or otherwise, to any person or official, personnel or representative of the government in relation to any procurement project or activity.

IN WITNESS WHEREOF, I have hereunto set my hand this ___ day of ___, 20__ at _____, Philippines.

Bidder's Representative/Authorized Signatory

SUBSCRIBED AND SWORN to before me this ___ day of [month] [year] at [place of execution], Philippines. Affiant/s is/are personally known to me and was/were identified by me through competent evidence of identity as defined in the 2004 Rules on Notarial Practice (A.M. No. 02-8-13-SC). Affiant/s exhibited to me his/her [insert type of government identification card used], with his/her photograph and signature appearing thereon, with no. _____ and his/her Community Tax Certificate No. _____ issued on ___ at _____.

Witness my hand and seal this ___ day of [month] [year].

NAME OF NOTARY PUBLIC

Serial No. of Commission _____

Notary Public for _____ until _____

Roll of Attorneys No. _____

PTR No. _____ [date issued], [place issued]

IBP No. _____ [date issued], [place issued]

Doc. No. _____

Page No. _____

Book No. _____

Series of _____

SEALING AND MARKING OF BIDS

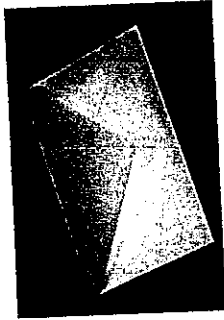
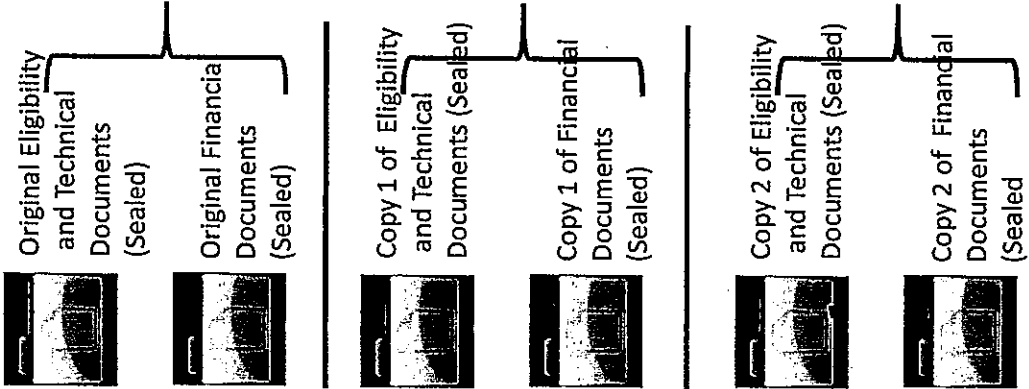

ORIGINAL BID (Sealed)

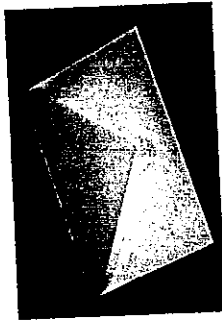

COPY 1 (Sealed)

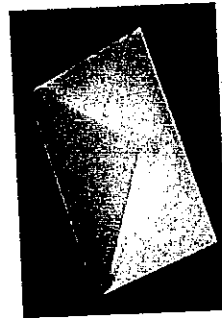

COPY 2 (Sealed)

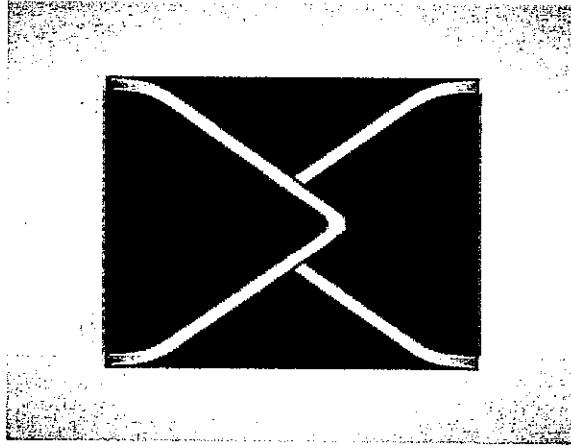

MAIN ENVELOPE (Sealed)

NAME OF CONTRACT TO BE BID

NAME AND ADDRESS OF BIDD

BAC/PROCURING ENTITY

DO NOT OPEN BEFORE