

# **PHILIPPINE INTERNATIONAL CONVENTION CENTER**



## **BIDDING DOCUMENTS (INFRASTRUCTURE PROJECTS)**

**PROJECT TITLE : SUPPLY OF LABOR AND MATERIALS FOR  
THE REPLACEMENT OF THE BULLET  
RESISTANT GLASS DOORS OF HEROES  
ROOM**

**ABC : Php1,865,855.00**

**Reference : APP No. 2023 – MC – 15**

**ITB-2023  
January 19, 2023**

# TABLE OF CONTENTS

<b>Glossary of Terms, Abbreviations, and Acronyms.....</b>	<b>4</b>
<b>Section I. Invitation to Bid .....</b>	<b>7</b>
<b>Section II. Instruction to Bidders .....</b>	<b>10</b>
1. Scope of Bid .....	11
2. Funding Information .....	11
3. Bidding Requirements .....	11
4. Corrupt, Fraudulent, Collusive .....	11
5. Eligible Bidders .....	12
6. Origin of Associated Goods .....	12
7. Subcontracts .....	12
8. Pre-bid Conference .....	13
9. Clarification and Amendments of Bidding Documents .....	13
10. Documents Comprising the Bid: Eligibility and Technical Component .....	13
11. Documents Comprising the Bid: Eligibility and Technical Component .....	14
12. Alternative Bids .....	14
13. Bid Prices .....	14
14. Bid and Payment Currencies .....	14
15. Bid Security .....	15
16. Sealing and Marking of Bids .....	15
17. Deadline for Submission of Bids .....	15
18. Opening and Preliminary Examinations of Bids .....	15
19. Detailed Evaluation and Comparison of Bids .....	15
20. Post Qualification .....	16
21. Signing of the Contract .....	16
<b>Section III. Bid Data Sheet.....</b>	<b>17</b>
<b>Section IV. General Conditions of Contract.....</b>	<b>20</b>
1. Scope of Contract .....	21
2. Sectional Completion of Works .....	21
3. Possession of Site .....	21
4. The Contractor's Obligation .....	21
5. Performance Security .....	22

6. Site Investigation Reports .....	22
7. Warranty .....	22
8. Liability of the Contract .....	22
9. Termination for other Causes .....	22
10. Dayworks .....	22
11. Program of Works .....	23
12. Instructions, Inspections and Audits .....	23
13. Advance Payments .....	23
14. Progress Payments .....	23
15. Operating and Maintenance Manuals.....	23
<b>Section V. Special Conditions of Contract .....</b>	<b>24</b>
<b>Section VI. Specifications.....</b>	<b>27</b>
<b>Section VII. Drawings .....</b>	<b>32</b>
<b>Section VIII. Bill of Quantities.....</b>	<b>34</b>
<b>Section IX. Checklist of Technical and Financial Documents .....</b>	<b>36</b>

# *Glossary of Terms, Abbreviations, and Acronyms*

**ABC** – Approved Budget for the Contract.

**ARCC** – Allowable Range of Contract Cost.

**BAC** – Bids and Awards Committee.

**Bid** – A signed offer or proposal to undertake a contract submitted by a bidder in response to and in consonance with the requirements of the bidding documents. Also referred to as *Proposal* and *Tender*. (2016 revised IRR, Section 5[c])

**Bidder** – Refers to a contractor, manufacturer, supplier, distributor and/or consultant who submits a bid in response to the requirements of the Bidding Documents. (2016 revised IRR, Section 5[d])

**Bidding Documents** – The documents issued by the Procuring Entity as the bases for bids, furnishing all information necessary for a prospective bidder to prepare a bid for the Goods, Infrastructure Projects, and/or Consulting Services required by the Procuring Entity. (2016 revised IRR, Section 5[e])

**BIR** – Bureau of Internal Revenue.

**BSP** – Bangko Sentral ng Pilipinas.

**CDA** – Cooperative Development Authority.

**Consulting Services** – Refer to services for Infrastructure Projects and other types of projects or activities of the GOP requiring adequate external technical and professional expertise that are beyond the capability and/or capacity of the GOP to undertake such as, but not limited to: (i) advisory and review services; (ii) pre-investment or feasibility studies; (iii) design; (iv) construction supervision; (v) management and related services; and (vi) other technical services or special studies. (2016 revised IRR, Section 5[i])

**Contract** – Refers to the agreement entered into between the Procuring Entity and the Supplier or Manufacturer or Distributor or Service Provider for procurement of Goods and Services; Contractor for Procurement of Infrastructure Projects; or Consultant or Consulting Firm for Procurement of Consulting Services; as the case may be, as recorded in the Contract Form signed by the parties, including all attachments and appendices thereto and all documents incorporated by reference therein.

**Contractor** – is a natural or juridical entity whose proposal was accepted by the Procuring Entity and to whom the Contract to execute the Work was awarded. Contractor as used in these Bidding Documents may likewise refer to a supplier, distributor, manufacturer, or consultant.

**CPI** – Consumer Price Index.

**DOLE** – Department of Labor and Employment.

**DTI** – Department of Trade and Industry.

**Foreign-funded Procurement or Foreign-Assisted Project** – Refers to procurement whose funding source is from a foreign government, foreign or international financing institution as specified in the Treaty or International or Executive Agreement. (2016 revised IRR, Section 5[b]).

**GFI** – Government Financial Institution.

**GOCC** – Government-owned and/or –controlled corporation.

**Goods** – Refer to all items, supplies, materials and general support services, except Consulting Services and Infrastructure Projects, which may be needed in the transaction of public businesses or in the pursuit of any government undertaking, project or activity, whether in the nature of equipment, furniture, stationery, materials for construction, or personal property of any kind, including non-personal or contractual services such as the repair and maintenance of equipment and furniture, as well as trucking, hauling, janitorial, security, and related or analogous services, as well as procurement of materials and supplies provided by the Procuring Entity for such services. The term “related” or “analogous services” shall include, but is not limited to, lease or purchase of office space, media advertisements, health maintenance services, and other services essential to the operation of the Procuring Entity. (2016 revised IRR, Section 5[r])

**GOP** – Government of the Philippines.

**Infrastructure Projects** – Include the construction, improvement, rehabilitation, demolition, repair, restoration or maintenance of roads and bridges, railways, airports, seaports, communication facilities, civil works components of information technology projects, irrigation, flood control and drainage, water supply, sanitation, sewerage and solid waste management systems, shore protection, energy/power and electrification facilities, national buildings, school buildings, hospital buildings, and other related construction projects of the government. Also referred to as *civil works or works*. (2016 revised IRR, Section 5[u])

**LGUs** – Local Government Units.

**NFCC** – Net Financial Contracting Capacity.

**NGA** – National Government Agency.

**PCAB** – Philippine Contractors Accreditation Board.

**PhilGEPS** - Philippine Government Electronic Procurement System.

**Procurement Project** – refers to a specific or identified procurement covering goods, infrastructure project or consulting services. A Procurement Project shall be described, detailed, and scheduled in the Project Procurement Management Plan prepared by the agency which shall be consolidated in the procuring entity's Annual Procurement Plan. (GPPB Circular No. 06-2019 dated 17 July 2019)

**PSA** – Philippine Statistics Authority.

**SEC** – Securities and Exchange Commission.

**SLCC** – Single Largest Completed Contract.

**UN** – United Nations.

## *Section I. Invitation to Bid*

## **BIDS AND AWARDS COMMITTEE**

### **Invitation to Bid for Supply of Labor and Materials for the Replacement of the Bullet Resistant Glass Doors at the Heroes Room**

1. The *Philippine International Convention Center (PICC)*, through the *Approved Budget for CY 2023* intends to apply the sum of **ONE MILLION EIGHT HUNDRED SIXTY-FIVE THOUSAND EIGHT HUNDRED FIFTY-FIVE PESOS (Php1,865,855.00)**, **VAT Inclusive**, being the Approved Budget for the Contract (ABC) to payments under the contract for **Supply of Labor and Materials for the Replacement of the Bullet Resistant Glass Doors at the Heroes Room (APP No. 2023 – MC - 15)**. Bids received in excess of the ABC shall be automatically rejected at bid opening.
2. The *PICC* now invites bids for the above Procurement Project. Completion of the Works is required within Sixty (60) CALENDAR DAYS. Bidders should have completed a contract similar to the Project. The description of an eligible bidder is contained in the Bidding Documents, particularly, in Section II (Instructions to Bidders).
3. Bidding will be conducted through open competitive bidding procedures using non-discretionary “*pass/fail*” criterion as specified in the 2016 Revised Implementing Rules and Regulations (IRR) of Republic Act (RA) No. 9184.
4. Prospective Bidders may obtain further information from the *PICC-BAC* and inspect the Bidding Documents at the address given below during office hours.
5. A complete set of Bidding Documents may be acquired by prospective bidders starting January 25, 2023 from the given address and website/s below *and upon payment of a non-refundable fee, in the amount of Two Thousand Pesos (Php2,000.00)*. A bidder shall present its proof of payment for the fee *by furnishing the PICC-BAC a copy of the Official Receipt*.
6. The *PICC-BAC* will hold a Pre-Bid Conference on February 8, 2023, *at 11:00 a.m.*, at *Meeting Room 10, 3<sup>rd</sup> Floor, Delegation Building, PICC* and/or through videoconferencing/webcasting *via Zoom*, which shall be open to prospective bidders.
7. Bids must be duly received by the BAC Secretariat through manual submission at the office address as indicated below, on or before February 20, 2023, *at 9:30 a.m.* Late bids shall not be accepted.
8. All bids must be accompanied by a bid security in any of the acceptable forms and in the amount stated in **ITB Clause 15**.
9. Bid opening shall be on February 20, 2022 *at 10:00 a.m.* at the given address below. Bids will be opened in the presence of the bidders’ representatives who choose to attend the activity.



10. The *PICC* reserves the right to reject any and all bids, declare a failure of bidding, or not award the contract at any time prior to contract award in accordance with Sections 35.6 and 41 of the 2016 revised Implementing Rules and Regulations (IRR) of RA No. 9184, without thereby incurring any liability to the affected bidder or bidders.

11. For further information, please refer to:

*BIDS AND AWARDS COMMITTEE  
PHILIPPINE INTERNATIONAL CONVENTION CENTER  
PICC Complex, Pasay City 1307  
87894759 and 87894760  
Telefax No. 87894761  
Email: [procurement@picc.gov.ph](mailto:procurement@picc.gov.ph)*

12. You may visit the following websites:

For downloading of Bidding Documents: [www.picc.gov.ph](http://www.picc.gov.ph)

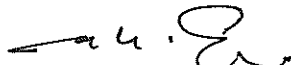
  
**MELPIN A. GONZAGA**  
Chairman

## *Section II. Instructions to Bidders*

## 1. **Scope of Bid**

The Procuring Entity, *Philippine International Convention Center* invites Bids for the **Supply of Labor and Materials for the Replacement of the Bullet Resistant Glass Doors of Heroes Room**, with Project Identification Number PICC APP No. 2023-MC-15.

The Procurement Project (referred to herein as “Project”) is for the construction of Works, as described in Section VI (Specifications).

## 2. **Funding Information**

2.1. The GOP through the source of funding as indicated below for 2023 in the amount of Php1,865,855.00.

2.2. The source of funding is:

- a. GOCC and GFIs, the Corporate Operating Budget.

## 3. **Bidding Requirements**

The Bidding for the Project shall be governed by all the provisions of RA No. 9184 and its 2016 revised IRR, including its Generic Procurement Manual and associated policies, rules and regulations as the primary source thereof, while the herein clauses shall serve as the secondary source thereof.

Any amendments made to the IRR and other GPPB issuances shall be applicable only to the ongoing posting, advertisement, or invitation to bid by the BAC through the issuance of a supplemental or bid bulletin.

The Bidder, by the act of submitting its Bid, shall be deemed to have inspected the site, determined the general characteristics of the contracted Works and the conditions for this Project, such as the location and the nature of the work; (b) climatic conditions; (c) transportation facilities; (c) nature and condition of the terrain, geological conditions at the site communication facilities, requirements, location and availability of construction aggregates and other materials, labor, water, electric power and access roads; and (d) other factors that may affect the cost, duration and execution or implementation of the contract, project, or work and examine all instructions, forms, terms, and project requirements in the Bidding Documents.

## 4. **Corrupt, Fraudulent, Collusive, Coercive, and Obstructive Practices**

The Procuring Entity, as well as the Bidders and Contractors, shall observe the highest standard of ethics during the procurement and execution of the contract. They or through an agent shall not engage in corrupt, fraudulent, collusive, coercive, and obstructive practices defined under Annex “I” of the 2016 revised IRR of RA No. 9184 or other integrity violations in competing for the Project.

## 5. Eligible Bidders

- 5.1. Only Bids of Bidders found to be legally, technically, and financially capable will be evaluated.
- 5.2. The Bidder must have an experience of having completed a Single Largest Completed Contract (SLCC) that is similar to this Project, equivalent to at least fifty percent (50%) of the ABC adjusted, if necessary, by the Bidder to current prices using the PSA's CPI, except under conditions provided for in Section 23.4.2.4 of the 2016 revised IRR of RA No. 9184.

A contract is considered to be "similar" to the contract to be bid if it has the major categories of work stated in the **BDS**.

- 5.3. For Foreign-funded Procurement, the Procuring Entity and the foreign government/foreign or international financing institution may agree on another track record requirement, as specified in the Bidding Document prepared for this purpose.
- 5.4. The Bidders shall comply with the eligibility criteria under Section 23.4.2 of the 2016 IRR of RA No. 9184.

## 6. Origin of Associated Goods

There is no restriction on the origin of Goods other than those prohibited by a decision of the UN Security Council taken under Chapter VII of the Charter of the UN.

## 7. Subcontracts

- 7.1. The Bidder may subcontract portions of the Project to the extent allowed by the Procuring Entity as stated herein, but in no case more than fifty percent (50%) of the Project.

The Procuring Entity has prescribed that:

- a. Subcontracting is not allowed.
- 7.1. *[If Procuring Entity has determined that subcontracting is allowed during the bidding, state:]* The Bidder must submit together with its Bid the documentary requirements of the subcontractor(s) complying with the eligibility criteria stated in **ITB** Clause 5 in accordance with Section 23.4 of the 2016 revised IRR of RA No. 9184 pursuant to Section 23.1 thereof.
  - 7.2. *[If subcontracting is allowed during the contract implementation stage, state:]* The Supplier may identify its subcontractor during the contract implementation stage. Subcontractors identified during the bidding may be changed during the implementation of this Contract. Subcontractors must submit the documentary requirements under Section 23.1 of the 2016 revised IRR of RA No. 9184 and comply with the eligibility criteria specified in **ITB** Clause 5 to the implementing or end-user unit.

- 7.3. Subcontracting of any portion of the Project does not relieve the Contractor of any liability or obligation under the Contract. The Supplier will be responsible for the acts, defaults, and negligence of any subcontractor, its agents, servants, or workmen as fully as if these were the Contractor's own acts, defaults, or negligence, or those of its agents, servants, or workmen.

## **8. Pre-Bid Conference**

The Procuring Entity will hold a pre-bid conference for this Project on the specified date and time and either at its physical address and/or through videoconferencing/webcasting as indicated in paragraph 6 of the **IB**.

## **9. Clarification and Amendment of Bidding Documents**

Prospective bidders may request for clarification on and/or interpretation of any part of the Bidding Documents. Such requests must be in writing and received by the Procuring Entity, either at its given address or through electronic mail indicated in the **IB**, at least ten (10) calendar days before the deadline set for the submission and receipt of Bids.

## **10. Documents Comprising the Bid: Eligibility and Technical Components**

- 10.1. The first envelope shall contain the eligibility and technical documents of the Bid as specified in **Section IX. Checklist of Technical and Financial Documents**.
- 10.2. If the eligibility requirements or statements, the bids, and all other documents for submission to the BAC are in foreign language other than English, it must be accompanied by a translation in English, which shall be authenticated by the appropriate Philippine foreign service establishment, post, or the equivalent office having jurisdiction over the foreign bidder's affairs in the Philippines. For Contracting Parties to the Apostille Convention, only the translated documents shall be authenticated through an apostille pursuant to GPPB Resolution No. 13-2019 dated 23 May 2019. The English translation shall govern, for purposes of interpretation of the bid.
- 10.3. A valid PCAB License is required, and in case of joint ventures, a valid special PCAB License, and registration for the type and cost of the contract for this Project. Any additional type of Contractor license or permit shall be indicated in the **BDS**.
- 10.4. A List of Contractor's key personnel (e.g., Project Manager, Project Engineers, Materials Engineers, and Foremen) assigned to the contract to be bid, with their complete qualification and experience data shall be provided. These key personnel must meet the required minimum years of experience set in the **BDS**.
- 10.5. A List of Contractor's major equipment units, which are owned, leased, and/or under purchase agreements, supported by proof of ownership, certification of

availability of equipment from the equipment lessor/vendor for the duration of the project, as the case may be, must meet the minimum requirements for the contract set in the **BDS**.

## **11. Documents Comprising the Bid: Financial Component**

- 11.1. The second bid envelope shall contain the financial documents for the Bid as specified in **Section IX. Checklist of Technical and Financial Documents**.
- 11.2. Any bid exceeding the ABC indicated in paragraph 1 of the **IB** shall not be accepted.
- 11.3. For Foreign-funded procurement, a ceiling may be applied to bid prices provided the conditions are met under Section 31.2 of the 2016 revised IRR of RA No. 9184.

## **12. Alternative Bids**

Bidders shall submit offers that comply with the requirements of the Bidding Documents, including the basic technical design as indicated in the drawings and specifications. Unless there is a value engineering clause in the **BDS**, alternative Bids shall not be accepted.

## **13. Bid Prices**

All bid prices for the given scope of work in the Project as awarded shall be considered as fixed prices, and therefore not subject to price escalation during contract implementation, except under extraordinary circumstances as determined by the NEDA and approved by the GPPB pursuant to the revised Guidelines for Contract Price Escalation guidelines.

## **14. Bid and Payment Currencies**

- 14.1. Bid prices may be quoted in the local currency or tradeable currency accepted by the BSP at the discretion of the Bidder. However, for purposes of bid evaluation, Bids denominated in foreign currencies shall be converted to Philippine currency based on the exchange rate as published in the BSP reference rate bulletin on the day of the bid opening.
- 14.2. *Payment of the contract price shall be made in Philippine Pesos.*

## **15. Bid Security**

- 15.1. The Bidder shall submit a Bid Securing Declaration or any form of Bid Security in the amount indicated in the **BDS**, which shall be not less than the percentage of the ABC in accordance with the schedule in the **BDS**.

- 15.2. The Bid and bid security shall be valid one hundred twenty (120) calendar days from the date of opening of bids. Any bid not accompanied by an acceptable bid security shall be rejected by the Procuring Entity as non-responsive.

## **16. Sealing and Marking of Bids**

Each Bidder shall submit one copy of the first and second components of its Bid.

The Procuring Entity may request additional hard copies and/or electronic copies of the Bid. However, failure of the Bidders to comply with the said request shall not be a ground for disqualification.

If the Procuring Entity allows the submission of bids through online submission to the given website or any other electronic means, the Bidder shall submit an electronic copy of its Bid, which must be digitally signed. An electronic copy that cannot be opened or is corrupted shall be considered non-responsive and, thus, automatically disqualified.

## **17. Deadline for Submission of Bids**

The Bidders shall submit on the specified date and time and either at its physical address or through online submission as indicated in paragraph 7 of the **IB**.

## **18. Opening and Preliminary Examination of Bids**

- 18.1. The BAC shall open the Bids in public at the time, on the date, and at the place specified in paragraph 9 of the **IB**. The Bidders' representatives who are present shall sign a register evidencing their attendance. In case videoconferencing, webcasting or other similar technologies will be used, attendance of participants shall likewise be recorded by the BAC Secretariat.

In case the Bids cannot be opened as scheduled due to justifiable reasons, the rescheduling requirements under Section 29 of the 2016 revised IRR of RA No. 9184 shall prevail.

- 18.2. The preliminary examination of Bids shall be governed by Section 30 of the 2016 revised IRR of RA No. 9184.

## **19. Detailed Evaluation and Comparison of Bids**

- 19.1. The Procuring Entity's BAC shall immediately conduct a detailed evaluation of all Bids rated "*passed*" using non-discretionary pass/fail criteria. The BAC shall consider the conditions in the evaluation of Bids under Section 32.2 of 2016 revised IRR of RA No. 9184.
- 19.2. If the Project allows partial bids, all Bids and combinations of Bids as indicated in the **BDS** shall be received by the same deadline and opened and evaluated simultaneously so as to determine the Bid or combination of Bids offering the lowest calculated cost to the Procuring Entity. Bid Security as required by **ITB** Clause 16 shall be submitted for each contract (lot) separately.

19.3. In all cases, the NFCC computation pursuant to Section 23.4.2.6 of the 2016 revised IRR of RA No. 9184 must be sufficient for the total of the ABCs for all the lots participated in by the prospective Bidder.

## **20. Post Qualification**

Within a non-extendible period of five (5) calendar days from receipt by the Bidder of the notice from the BAC that it submitted the Lowest Calculated Bid, the Bidder shall submit its latest income and business tax returns filed and paid through the BIR Electronic Filing and Payment System (eFPS), and other appropriate licenses and permits required by law and stated in the **BDS**.

## **21. Signing of the Contract**

The documents required in Section 37.2 of the 2016 revised IRR of RA No. 9184 shall form part of the Contract. Additional Contract documents are indicated in the **BDS**.



*Section III. Bid Data Sheet*

# Bid Data Sheet

ITB Clause							
5	<p>The following persons shall be eligible to participate in this bidding:</p> <ul style="list-style-type: none"> <li>• Duly Licensed Filipino citizens/sole proprietorships;</li> <li>• Partnerships duly organized under the laws of the Philippines and of which at least sixty percent (60%) of the interest belongs to citizens of the Philippines;</li> <li>• Corporations duly organized under the laws of the Philippines, and of which at least sixty percent (60%) of the outstanding capital stocks belongs to citizens of the Philippines;</li> <li>• Cooperative duly organized under the laws of the Philippines, and of which at least sixty percent (60%) interest belongs to the citizens of the Philippines;</li> <li>• At least five (5) years of experience in civil works.</li> </ul>						
5.2	<p>The Bidder must have completed within five (5) years from the date of bidding, a single contract that is similar to this requirement, the amount of which shall be at least fifty percent (50%) of the ABC.</p> <p>For this purpose, a similar contracts to the Project refer to contracts involving installation of bullet resistant glass.</p>						
7.1	Subcontracting is not allowed.						
10.3	The Contractor shall be PCAB licensed with a classification of General Building, "D" category with at least five (5) years' work experience in civil works.						
10.4	<p>The key personnel must meet the required minimum years of experience set below:</p> <table border="1" style="width: 100%; border-collapse: collapse;"> <thead> <tr> <th style="text-align: center;">Key Personnel</th> <th style="text-align: center;">Relevant Experience</th> </tr> </thead> <tbody> <tr> <td style="text-align: center;">Project Supervisor – Civil or Mechanical Engineer</td> <td>Must have managed/supervised a completed project involving glass works.</td> </tr> <tr> <td style="text-align: center;">Safety Officer</td> <td>Minimum of three (3) years' work experience as Safety Officer/Practitioner. Must have Certificate of employment as Safety Officer and Certificate of training in Occupational Safety and Health from DOLE or any DOLE accredited training institution.</td> </tr> </tbody> </table>	Key Personnel	Relevant Experience	Project Supervisor – Civil or Mechanical Engineer	Must have managed/supervised a completed project involving glass works.	Safety Officer	Minimum of three (3) years' work experience as Safety Officer/Practitioner. Must have Certificate of employment as Safety Officer and Certificate of training in Occupational Safety and Health from DOLE or any DOLE accredited training institution.
Key Personnel	Relevant Experience						
Project Supervisor – Civil or Mechanical Engineer	Must have managed/supervised a completed project involving glass works.						
Safety Officer	Minimum of three (3) years' work experience as Safety Officer/Practitioner. Must have Certificate of employment as Safety Officer and Certificate of training in Occupational Safety and Health from DOLE or any DOLE accredited training institution.						
12	Not applicable.						

7

Ⓞ

15.1	<p>The bid security shall be in the form of a Bid Securing Declaration or any of the following forms and amounts:</p> <p>a. In the amount of not less than ₱37,317.10, Cash, cashier's/manager's check, bank draft/guarantee or irrevocable letter of credit;</p> <p>b. Surety Bond in the amount of not less than ₱93,292.75.</p>
15.2	The bid security shall be valid until <i>One Hundred Twenty (120) calendar days from the date of submission and opening of bids.</i>
16	<p>Sealing and Marking of Bids</p> <p>Each Bidder shall submit the original and one (1) copy of the first and second components of its Bid.</p>
16.1	<p>The address for submission of bids is:</p> <p style="text-align: center;">PICC-Bids and Awards Committee (BAC) Secretariat Ground floor, Delegation Building PICC Complex, 1307 Pasay City</p> <p>The deadline for submission of bids is February 20, 2023 at 9:30 a.m.</p>
17.1	<p>The place of bid</p> <p style="text-align: center;">BAC CONFERENCE ROOM MR10, 3<sup>rd</sup> Floor, Delegation Building PICC Complex, 1307 Pasay City</p> <p>The date and time of bid opening is February 20, 2023 at 10:00 a.m. In case the Bids cannot be opened as scheduled due to justifiable reasons, the BAC shall take custody of the Bids submitted and the opening of Bids shall be at 2:00 p.m. of the next working day.</p>
19.2	Not Applicable.
20	<p>Within a non-extendible period of five (5) calendar days from receipt of the notice from the BAC that it submitted the Lowest Calculated Bid, the Bidder shall submit the following;</p> <ol style="list-style-type: none"> <li>1. 2021 Income and Business Tax with proof of payment.</li> <li>2. Sections III and V of the Bid Documents, signed on each and every page by the bidder's authorized representative;</li> <li>3. Company profile with organizational chart and sketch of office location;</li> <li>4. Resume of key personnel who will be assigned to the project;</li> <li>5. Certification that the participating bidder has conducted ocular inspection of the subject requirements; and</li> <li>6. Certificate of Satisfactory Completion and Acceptance of previous PICC projects undertaken within the last five (5) years, if any.</li> </ol>

21	<p>The following documents shall be submitted, together with the Performance Bond, within ten (10) calendar days after the receipt of the Notice of Award. Such documents shall form part of the contract;</p> <ol style="list-style-type: none"><li>1. Project Schedule/ Work Program;</li><li>2. Project Safety and Health Program signed by the Safety Officer; and</li><li>3. The 1 ft. x 1ft. glass sample and Research Development Center of the Philippine Army (RDC-PA) certificate (see item 7 of page 31).</li></ol>
----	--

## *Section IV. General Conditions of Contract*

## 1. **Scope of Contract**

This Contract shall include all such items, although not specifically mentioned, that can be reasonably inferred as being required for its completion as if such items were expressly mentioned herein. All the provisions of RA No. 9184 and its 2016 revised IRR, including the Generic Procurement Manual, and associated issuances, constitute the primary source for the terms and conditions of the Contract, and thus, applicable in contract implementation. Herein clauses shall serve as the secondary source for the terms and conditions of the Contract.

This is without prejudice to Sections 74.1 and 74.2 of the 2016 revised IRR of RA No. 9184 allowing the GPPB to amend the IRR, which shall be applied to all procurement activities, the advertisement, posting, or invitation of which were issued after the effectivity of the said amendment.

## 2. **Sectional Completion of Works**

If sectional completion is specified in the **Special Conditions of Contract (SCC)**, references in the Conditions of Contract to the Works, the Completion Date, and the Intended Completion Date shall apply to any Section of the Works (other than references to the Completion Date and Intended Completion Date for the whole of the Works).

## 3. **Possession of Site**

- 3.1 The Procuring Entity shall give possession of all or parts of the Site to the Contractor based on the schedule of delivery indicated in the **SCC**, which corresponds to the execution of the Works. If the Contractor suffers delay or incurs cost from failure on the part of the Procuring Entity to give possession in accordance with the terms of this clause, the Procuring Entity's Representative shall give the Contractor a Contract Time Extension and certify such sum as fair to cover the cost incurred, which sum shall be paid by Procuring Entity.
- 3.2 If possession of a portion is not given by the above date, the Procuring Entity will be deemed to have delayed the start of the relevant activities. The resulting adjustments in contract time to address such delay may be addressed through contract extension provided under Annex "E" of the 2016 revised IRR of RA No. 9184.

## 4. **The Contractor's Obligations**

The Contractor shall employ the key personnel named in the Schedule of Key Personnel indicating their designation, in accordance with **ITB** Clause 10.3 and specified in the **BDS**, to carry out the supervision of the Works.

The Procuring Entity will approve any proposed replacement of key personnel only if their relevant qualifications and abilities are equal to or better than those of the personnel listed in the Schedule.

## **5. Performance Security**

- 5.1. Within ten (10) calendar days from receipt of the Notice of Award from the Procuring Entity but in no case later than the signing of the contract by both parties, the successful Bidder shall furnish the performance security in any of the forms prescribed in Section 39 of the 2016 revised IRR.
- 5.2. The Contractor, by entering into the Contract with the Procuring Entity, acknowledges the right of the Procuring Entity to institute action pursuant to RA No. 3688 against any subcontractor be they an individual, firm, partnership, corporation, or association supplying the Contractor with labor, materials and/or equipment for the performance of this Contract.

## **6. Site Investigation Reports**

The Contractor, in preparing the Bid, shall rely on any Site Investigation Reports referred to in the SCC supplemented by any information obtained by the Contractor.

## **7. Warranty**

- 7.1. In case the Contractor fails to undertake the repair works under Section 62.2.2 of the 2016 revised IRR, the Procuring Entity shall forfeit its performance security, subject its property(ies) to attachment or garnishment proceedings, and perpetually disqualify it from participating in any public bidding. All payables of the GOP in his favor shall be offset to recover the costs.
- 7.2. The warranty against Structural Defects/Failures, except that occasioned-on force majeure, shall cover the period from the date of issuance of the Certificate of Final Acceptance by the Procuring Entity. Specific duration of the warranty is found in the SCC.

## **8. Liability of the Contractor**

Subject to additional provisions, if any, set forth in the SCC, the Contractor's liability under this Contract shall be as provided by the laws of the Republic of the Philippines.

If the Contractor is a joint venture, all partners to the joint venture shall be jointly and severally liable to the Procuring Entity.

## **9. Termination for Other Causes**

Contract termination shall be initiated in case it is determined *prima facie* by the Procuring Entity that the Contractor has engaged, before, or during the implementation of the contract, in unlawful deeds and behaviors relative to contract acquisition and implementation, such as, but not limited to corrupt, fraudulent, collusive, coercive, and obstructive practices as stated in ITB Clause 4.

## **10. Dayworks**

Subject to the guidelines on Variation Order in Annex "E" of the 2016 revised IRR of RA No. 9184, and if applicable as indicated in the SCC, the Dayworks rates in the

Contractor's Bid shall be used for small additional amounts of work only when the Procuring Entity's Representative has given written instructions in advance for additional work to be paid for in that way.

## **11. Program of Work**

11.1. The Contractor shall submit to the Procuring Entity's Representative for approval the said Program of Work showing the general methods, arrangements, order, and timing for all the activities in the Works. The submissions of the Program of Work are indicated in the SCC.

11.2. The Contractor shall submit to the Procuring Entity's Representative for approval an updated Program of Work at intervals no longer than the period stated in the SCC. If the Contractor does not submit an updated Program of Work within this period, the Procuring Entity's Representative may withhold the amount stated in the SCC from the next payment certificate and continue to withhold this amount until the next payment after the date on which the overdue Program of Work has been submitted.

## **12. Instructions, Inspections and Audits**

The Contractor shall permit the GOP or the Procuring Entity to inspect the Contractor's accounts and records relating to the performance of the Contractor and to have them audited by auditors of the GOP or the Procuring Entity, as may be required.

## **13. Advance Payment**

The Procuring Entity shall, upon a written request of the Contractor which shall be submitted as a Contract document, make an advance payment to the Contractor in an amount not exceeding fifteen percent (15%) of the total contract price, to be made in lump sum, or at the most two installments according to a schedule specified in the SCC, subject to the requirements in Annex "E" of the 2016 revised IRR of RA No. 9184.

## **14. Progress Payments**

The Contractor may submit a request for payment for Work accomplished. Such requests for payment shall be verified and certified by the Procuring Entity's Representative/Project Engineer. Except as otherwise stipulated in the SCC, materials and equipment delivered on the site but not completely put in place shall not be included for payment.

## **15. Operating and Maintenance Manuals**

15.1. If required, the Contractor will provide "as built" Drawings and maintenance manuals as specified in the SCC.

15.2. If the Contractor does not provide the Drawings and/or manuals by the dates stated above, or they do not receive the Procuring Entity's Representative's approval, the Procuring Entity's Representative may withhold the amount stated in the SCC from payments due to the Contractor.



*Section V. Special Conditions of Contract*

# Special Conditions of Contract

GCC Clause	
2	The schedule of Completion is within Sixty (60) CALENDAR DAYS reckoned seven (7) calendar days after the receipt of the Notice to Proceed (NTP).
3.1	The site shall be available to the Contractor within seven (7) calendar days after issuance of NTP.
6	The Site is located at the Heroes Room
7.2	<p><b>WARRANTY:</b></p> <p>The warranty period shall be <b>Three (3) year</b> reckoned from the date of final turn-over and acceptance. The obligation for the warranty shall be covered by either <b>retention money</b> equivalent to five (5) percent of the total contract amount or a <b>special bank guarantee</b> equivalent to five (5) percent of the total contract amount. Said amounts shall only be released after the lapse of the warranty period.</p>
10	Dayworks are applicable at the rate shown in the Contractor's original Bid.
11.1	The Contractor shall submit the Program of Work to the Procuring Entity's Representative within ten (10) calendar days upon receipt of Notice of Award.
14	<p><b>Payment</b></p> <p>1. Full payment shall be made upon completion of the project and submission of the following documents:</p> <ul style="list-style-type: none"> <li>• Letter request of the Contractor for the release of the payment for work accomplished</li> <li>• Breakdown of work accomplished as validated and certified by PICC Representative</li> <li>• Photographs of work accomplished</li> <li>• As-Built Plan in soft and hard copy. The hard copy shall be in A3 bond size, three (3) copies signed by the CONTRACTOR and PICC authorized representative. The soft copy shall be saved in a USB.</li> <li>• Invoice</li> </ul> <p>2. Full payment shall be subject to the following:</p> <ul style="list-style-type: none"> <li>• Five percent (5%) of the Contract amount as retention money. The total "retention money" shall be due for release upon final acceptance of the works or after one (1) year from date of turn-over and acceptance of the project.</li> </ul>

	<p>3. The PICC representative shall check the Contractor's request for payment and certify the amount to be paid to the Contractor. Materials and equipment delivered on the site but not completely put in place shall not be included for payment.</p> <p>4. The PICC shall deduct the following from the certified gross amounts to be paid to the contractor's full payment.</p> <ul style="list-style-type: none"><li>• 5% as Retention money</li><li>• Amount to cover the third party liabilities</li></ul>
--	--

gv

Ⓟ

## *Section VI. Specifications*

**SUPPLY OF LABOR AND MATERIALS FOR THE REPLACEMENT OF THE BULLET RESISTANT GLASS DOORS OF HEROES ROOM**

**I. SCOPE OF WORKS and SPECIFICATIONS:**

The works shall be supply of all materials, labor, tools, equipment and other incidental necessary for the replacement of the bullet resistant glass doors of the subject project.

The following features of the work shall be performed, but not limited to the following:

1. Mobilization
  - Manpower, tools, equipment and temporary warehouse.
2. Health and Safety requirements
  - a. Installation of safety signage, same as the PICC standard signage, 22” x 32”.
  - b. Personal Protective Equipment (PPE). The Contractor shall comply with the protocol against COVID-19. All workers shall wear their company uniform together with the required PPEs.
3. Replacement of bullet resistant glass doors at Heroes Room:
  - a. Dismantling of existing bullet resistant glass doors and frames, see attached plan for details.
  - b. Supply and installation of door jamb and glass frame. The materials to be used shall be 304 stainless tubular steel-1.5mm thick with 304 stainless steel reinforced with tubular-2mm thick, color- black titanium brushed matte, see attached plan for details.
  - c. Supply and installation of bullet resistant glass. The bullet resistant glass shall be 25mm thick and compliant to National Institute of Justice (NIJ) 0108.01, Level II.

Test Variables			Performance Requirements			
Armor Type	Test Ammunition	Nominal Bullet Mass	Suggested Barrel Length	Required Bullet Velocity	Required Hits Per Armor Specimen	Permitted Penetrations
II	357 Magnum	10.2 g	15 to 16.5 cm	425 ± 15 m/s	5	0
	JSP	158 gr	6 to 6.5 in	1395 ± 50 ft/s		
	9mm	8.0 g	10 to 12 cm	358 ± 12m/s	5	0
	FMJ	124 gr	4 to 4.75 in	1175 ± 40 ft/s		

- \* JSP – Jacketed Soft Point
- \* FMJ – Full Metal Jacket

## NIJ STANDARD: TEST METHOD

### Type II Test Weapon and Ammunition

**Higher Velocity 357 Magnum:** The test weapon may be a 357 Magnum handgun or test barrel. The use of a handgun with a 15 to 16.5 cm (6 to 6.5 in) barrel is suggested. Test Bullets shall be 357 Magnum soft point, with nominal masses of 10.2 g (158gr) and measured velocities of  $425 \pm 15$  m ( $1395 \pm 50$  ft) per second.

**Higher Velocity 9 mm:** The test weapon may be a 9 mm handgun or test barrel. The use of a handgun with a 10 to 12 cm (4 to 4.75 in) barrel is suggested. Test Bullets shall be 9 mm full metal jacketed, with nominal masses of 8.0 g (124 gr) and measured velocities of  $358 \pm 12$  m ( $1175 \pm 40$  ft) per second.

- d. Supply and installation of two (2) heavy duty door closers, with hold and open features. Submit EN 1154 certificate of compliance. Submit brochure of door closer before installation for approval.
- e. Supply and installation of mortise lockset, stainless steel with four (4) sliding deadbolts plus one (1) spring bolt, measuring 240mm (Height) x 30mm (Width). Submit brochure of mortise lockset before installation for approval.
- f. Supply and installation of vertical locks, top and bottom, embedded into the door frame, solid stainless steel, spring-loaded, at least 304mm (length) with 10mm solid stainless steel round bolts.
- g. Supply and installation of heavy duty solid stainless steel hinges. 5 pcs. per door. Submit brochure of the hinges before installation for approval.

#### Hinge Specification:

	Capacity (kg)	Length (mm)	Width (mm)	Thickness (mm)
1 hinge	80	165	40	3

- h. Supply and installation of two (2) pcs. 304 stainless steel handle to be mounted over the mortise lockset. Submit brochure of mortise lockset before installation for approval.

4. Restoration work.

5. Hauling of dismantled bullet resistant glass doors and frames at PICC- workshop.

6. Demobilization

Manpower, tools, equipment, temporary warehouse, including hauling-out of construction debris.

7. Submission of Certificate from Research Development Center of the Philippine Army (RDC-PA) and Evaluation Sample

- a. The Contractor shall submit a 1 ft. x 1 ft. sample of the glass to be used. The sample shall be considered compliant and acceptable from RDC-PA stating that the submitted sample passed the testing of NIJ0108.01 Level 2.
- b. The sample and RDC-PA certificate must be submitted within ten (10) calendar days from receipt of the Notice of Award

**II. GENERAL CONDITIONS:**

1. The Contract Documents, Specifications and Drawings are mutually complimentary. What is noted in one although not shown in other shall be considered contained in all, in case of conflict. The Specifications shall prevail over the Drawings. The documents forming the Contract shall be interpreted in the following order of priority:
  - a. Contract/Construction Agreement
  - b. Contractor's Bid
  - c. Special Conditions of the Contract
  - d. Specifications
  - e. Drawings
  - f. Any other document listed in the Special Conditions of the Contract as forming part of the Contract
2. The Bidders shall examine all the issued documents relating to the work and must have verified all the existing conditions at the site. No consideration will be given for any alleged misunderstanding or misinterpretation of the specifications and materials to be used or work to be done.
3. The Bidders shall inspect and examine the site and the surroundings of the project to arrive at a reasonable estimate of the labor, materials, equipment, facilities and services necessary to carry out the works.
4. Tapping of equipment and other related works at the temporary facilities shall be properly coordinated with PICC Representative for provision of electrical power and water. For this purpose, the CONTRACTOR shall provide a sub-meter for power and water consumptions and shall be billed accordingly to the total kilowatt and volume utilized.
5. The Lowest Complying Bidder (LCB) shall submit 1ft. x 1 ft. sample of resistant bulletproof glass to be tested for NIJ 0108.01 Level 2, at the Research and Development Center of Philippine Army (RDC-PA). Testing to be witnessed by two (2) representative from the end-user and one (1) representative from the contractor. The cost of testing should be covered by the LCB. The passed and approved sample shall be retained by the end-user as its control sample.
6. The contractor must provide certificate from the bulletproof resistant glass manufacturer that the delivered bulletproof resistant glass is exactly the same in design and structure as the passed and approved sample.



### III. CONTRACTOR'S OBLIGATION:

1. The CONTRACTOR shall perform all works necessary to fully accomplish the project.
2. A joint ocular inspection must be conducted by the Contractor and PICC Representative to determine the actual condition of the area.
3. The CONTRACTOR shall commence execution of the works on the Start Date and shall carry out the works in accordance with the program of work submitted by the CONTRACTOR, as updated with the approval of PICC Representative and complete them by the intended completion date
4. The CONTRACTOR shall provide all supervision, labor, materials, plant and Contractor's equipment, which may be required.
5. The CONTRACTOR shall be liable to all health hazards for its workers, fire and accident claims and other related claims arising from the injuries and damages, which occurred in the vicinity. The Contractor shall submit a Safety and Health Program signed by the Contractor and its Safety Officer. The Contractor shall provide PPEs of its workers. No workers shall be allowed to work on site without PPEs like safety shoes, reflective vest and other necessary protective equipment as protection against COVID-19.
6. The CONTRACTOR shall free the PICC and its personnel from and against all liability for damages arising from injuries or liabilities to persons or damages to property by any act of omissions of the contractor including any and all expenses which may be incurred by its personnel in the defense of any claim, action or suit.
7. Any work that may affect the operation, security and image of the Center shall be coordinated properly with PICC Representative and shall be done in accordance with the Center's approved schedule.
8. Cost of rework and restoration or replacement of all damaged properties due to CONTRACTOR'S poor workmanship or negligence shall be borne by the Contractor.
9. The CONTRACTOR shall submit list of personnel assigned to the project including their NBI clearance before commencing the above scope of works.
10. The CONTRACTOR's personnel/workers must wear at all times their PPE, security ID issued by PICC and uniform while working inside the Center.
11. The CONTRACTOR shall provide three (3) years warranty certificate for the bullet resistant glass and its frame, including sagging and delamination of glass.

### IV. WORKMANSHIP:

The work throughout shall be executed in the best and most thorough manner to the satisfaction of PICC and its engineers and supervisors who will jointly interpret the





meaning of the scope of work and its conditions and shall have the power to reject any work, method of accomplishing every part of work and material used which in their judgment are not in full accordance therewith and are disadvantageous to PICC.

**V. LIQUIDATED DAMAGES:**

In case of delay in the completion period inclusive of duly granted time extensions, if any, the Contractor shall be liable for damages and shall pay the PICC for liquidated damages in an amount equivalent to at least one tenth (1/10) of one percent (1%) of the cost of the unperformed works/services for every day of delay.

The maximum deduction shall be ten percent (10%) of the amount of contract. Once the cumulative amount of liquidated damages reaches ten percent (10%) of the amount of the Contract, the procuring entity may rescind the award without prejudice to other courses of action and remedies open to it.

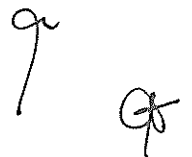

## *Section VII. Drawings*



<b>TITLE</b> SUPPLY OF LABOR AND MATERIALS FOR THE REPLACEMENT OF THE BULLET RESISTANT GLASS DOORS OF HEROES ROOM	<b>DATE</b> 10. 02. 2022	<b>REVISION</b> 11. 03. 2022	<b>DESIGNED BY</b> AR. RENE ALVARO DE MENDOZA JR. LEAD ARCHITECT	<b>RECOMMENDED APPROVAL</b> ENGR. VASCO B. DE LOS REYES DIRECTOR	<b>APPROVED BY</b> MR. RENE B. PADILLA SENIOR MANAGER	<b>SHEET NO.</b> 1 / 2
<b>LOCATION</b> PICC COMPLEX	<b>ARCHITECT</b> LOUIE JAY E. GADDON ARCHITECT	<b>CHECKED BY</b> ENGR. JERONIMO ATARDO ASSISTANT DIRECTOR	<b>MR. ROBERTO A. GARCIA</b> DEPT. GENERAL MANAGER	<b>1</b> A 1 SCALE 1 : 70 M.		<b>1</b> A 2

REPLACEMENT OF THE BULLET RESISTANT GLASS DOOR OF THE HEROES ROOM

**1**  
A 1  
SCALE  
1 : 70 M.

**LOCATION PLAN**

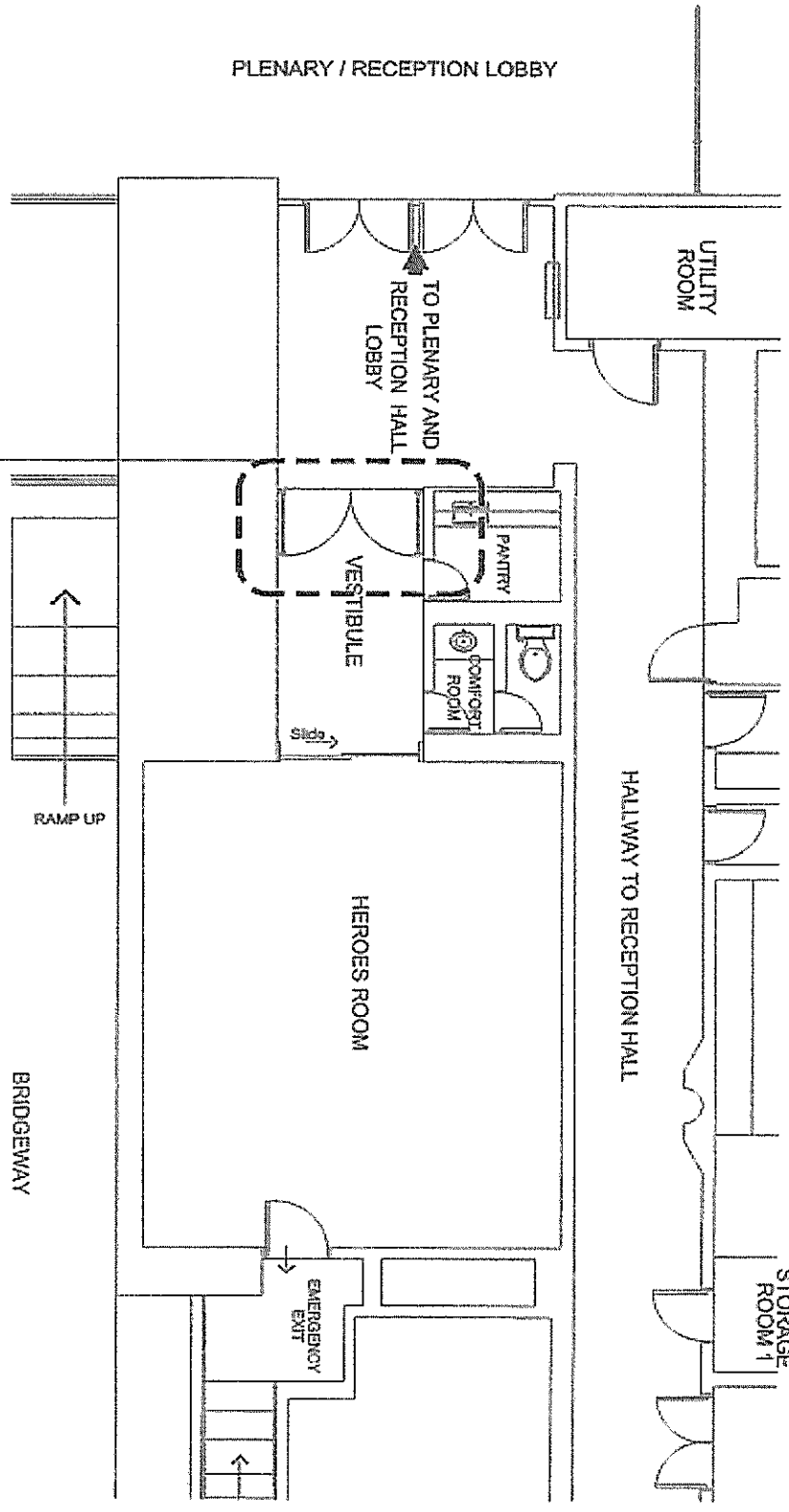

PLENARY / RECEPTION LOBBY

UTILITY ROOM

TO PLENARY AND RECEPTION HALL LOBBY

VESTIBULE

PANTRY

COAT ROOM

HALLWAY TO RECEPTION HALL

HEROES ROOM

STORAGE ROOM 1

RAMP UP

BRIDGEWAY

EMERGENCY EXIT



PROVIDE 2.0mm THK. COLOR - BLACK TITANIUM BRUSHED MATTE TUBULAR TO REINFORCED THE DOOR FRAME

25mm THK. BULLET RESISTANT GLASS

- 1. 5mm THK 304 STAINLESS STEEL- BLACK TITANIUM BRUSHED MATTE DOOR FRAME WITH 2 HEAVY DUTY DOOR CLOSER (WITH HOLD AND OPEN FEATURES), MOOREISE LOCKSET - 4 SLIDING STAINLESS STEEL BOLTS PLUS 1 SPRING BOLTS, VERTICAL LOCKS EMBEDDED INTO THE DOOR FRAMES,
- 5 PCS HEAVY DUTY SOLID STAINLESS HINGES PER DOOR AND STAINLESS STEEL HANDLES

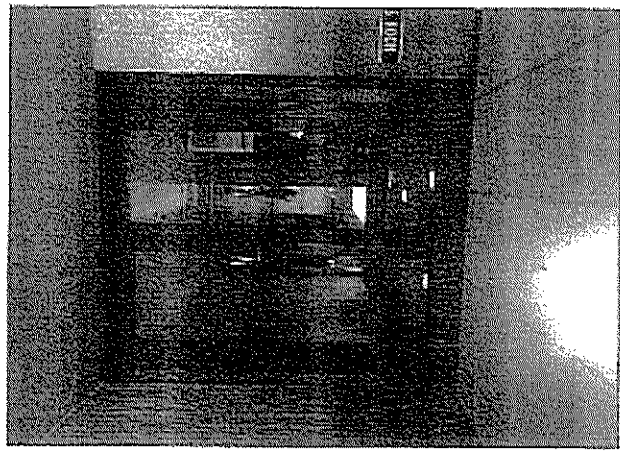

**EXISTING DOOR**

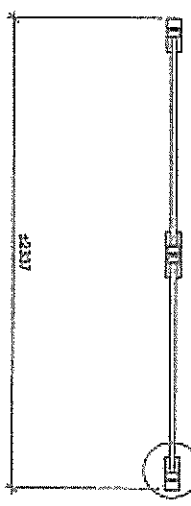
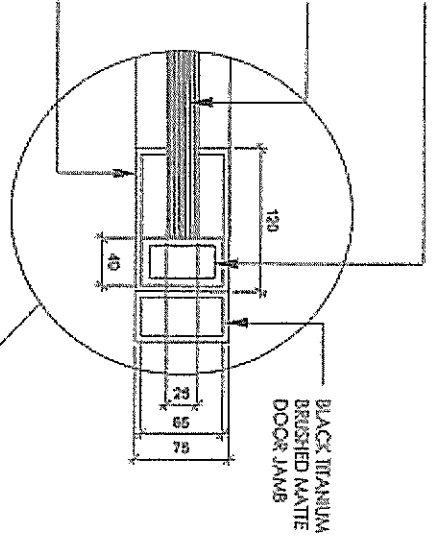

**1 PLAN**  
SCALE 1 : 70 M.

NOTE: VERIFY ACTUAL DIMENSION

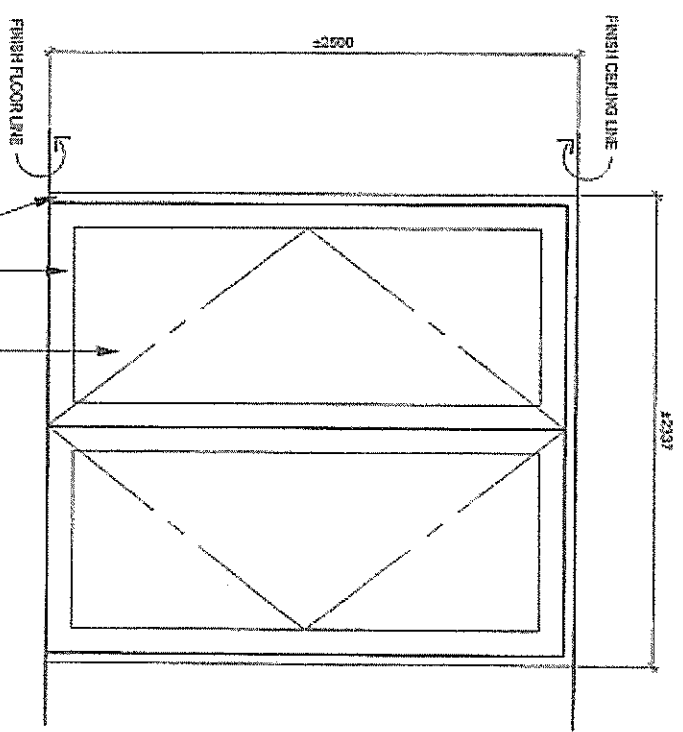

- 1. 5mm THK 304 STAINLESS STEEL- BLACK TITANIUM BRUSHED MATTE DOOR FRAMES AND JAMB. THE JAMB SHALL BE INSTALLED AND FIXED TO THE EXISTING STRUCTURE. PROVIDE NECESSARY BOLTS AND SCREWS AND ACCESSORIES TO HOLD AND SECURE THE JAMB.

**2 ELEVATION**  
SCALE 1 : 70 M.

<p>PICC PROYECTOS INTEGRADOS</p>	<p><b>TITLE</b></p> <p>SUPPLY OF LABOR AND MATERIALS FOR THE REPLACEMENT OF THE BULLET RESISTANT GLASS DOORS OF HEROES ROOM</p>		<p><b>DATE</b></p> <p>30. 03. 2023</p>		<p><b>REVISION</b></p> <p>11. 03. 2023</p>		<p><b>VERIFIED BY</b></p> <p>A.R. REYNALDO R. MENDOZA JR. DIR. GENERAL DE OPERACIONES</p>		<p><b>PROYECTANTE APROBADO</b></p> <p>ENGR. WILSON R. VELAZQUEZ REYES DIRECTOR GENERAL</p>		<p><b>PROYECTADO POR</b></p> <p>LOUIE JAY E. GARDON AUTOCAD OPERATOR</p>		<p><b>CHECADO POR</b></p> <p>ENGR. EDUARDO I. ARAUJO ASISTENTE DE PROYECTO SENIOR</p>		<p><b>PROYECTADO POR</b></p> <p>MR. EDUARDO A. GARCIA GEN. MANAGER</p>		<p><b>PROYECTADO POR</b></p> <p>ATTY. RAFAEL B. PADILLA GENERAL MANAGER</p>		<p><b>SHEET NO.</b></p> <p>2</p>	
	<p><b>LOCATION</b></p> <p>PICC COMPLEX</p>		<p><b>APPROVED BY</b></p> <p>LOUIE JAY E. GARDON AUTOCAD OPERATOR</p>		<p><b>CHECADO POR</b></p> <p>ENGR. EDUARDO I. ARAUJO ASISTENTE DE PROYECTO SENIOR</p>		<p><b>PROYECTADO POR</b></p> <p>MR. EDUARDO A. GARCIA GEN. MANAGER</p>		<p><b>PROYECTADO POR</b></p> <p>ATTY. RAFAEL B. PADILLA GENERAL MANAGER</p>		<p><b>SHEET NO.</b></p> <p>2</p>									

## *Section VIII. Bill of Quantities*

PROJECT : SUPPLY OF LABOR AND MATERIALS FOR THE REPLACEMENT OF THE BULLET RESISTANT GLASS DOORS OF HEROES ROOM

LOCATION : PICC COMPLEX, VICENTE SOTTO ST. PASAY CITY

DATE:

(1) ITEM NO.	(2) DESCRIPTION	(3) QTY.	(4) UNIT	(5) UNIT DIRECT COST	(6) ESTIMATED DIRECT COST (3 X 5)	(7) MARK-UPS		(10) % (7 + 8)	(11) VALUE (6 X 10)	(12) VAT 12 % 12% (6 + 11)	(13) TOTAL INDIRECT COST (11 + 12)	(14) TOTAL COST (6 + 13)	(15) UNIT COST (14/3)
						OCM %	PROFIT %						
<b>Part A - GENERAL REQUIREMENTS</b>													
A.1	General Requirements												
	Mobilization include the following:												
A.1.1	Mobilization of manpower and equipments/tools, Water and power consumption Temporary warehouse,	1.00	lot										
A.1.2	Demobilization include the following: Demobilization of manpower and equipments/tools Hauling of debris outside PICC Temporary warehouse, bonds, etc.	1.00	lot										
<b>TOTAL PART A</b>													
<b>Part B - Architectural Works</b>													
B.1	Replacement of bullet proof doors												
B.1.1	Bulleproof glass main doors complete with fittings and hardware specified	1.00	lot										
<b>TOTAL PART B</b>													
<b>TOTAL A + B</b>													
<b>TOTAL CONSTRUCTION COST</b>													

Prepared by:

Name of Company:

Date:

*Section IX. Checklist of Technical and Financial Documents*

# Checklist of Technical and Financial Documents

## I. TECHNICAL COMPONENT ENVELOPE

### *Class "A" Documents*

#### Legal Documents

- (a) Valid PhilGEPS Registration Certificate (Platinum Membership) (all pages);  
**or**
- (b) Registration certificate from Securities and Exchange Commission (SEC), Department of Trade and Industry (DTI) for sole proprietorship, or Cooperative Development Authority (CDA) for cooperatives or its equivalent document;  
**and**
- (c) Mayor's or Business permit issued by the city or municipality where the principal place of business of the prospective bidder is located, or the equivalent document for Exclusive Economic Zones or Areas;  
**and**
- (e) Tax clearance per E.O. No. 398, s. 2005, as finally reviewed and approved by the Bureau of Internal Revenue (BIR).

#### Technical Documents

- (f) Statement of the prospective bidder of all its ongoing government and private contracts, including contracts awarded but not yet started, if any, whether similar or not similar in nature and complexity to the contract to be bid (*Annex "A"*); **and**
- (g) Statement of the bidder's Single Largest Completed Contract (SLCC) similar to the contract to be bid, except under conditions provided under the rules (*Annex "B"*); **and**
- (h) Philippine Contractors Accreditation Board (PCAB) License;  
**or**  
Special PCAB License in case of Joint Ventures;  
**and** registration for the type and cost of the contract to be bid; **and**
- (i) Original copy of Bid Security. If in the form of a Surety Bond, submit also a certification issued by the Insurance Commission;  
**or**  
Original copy of Notarized Bid Securing Declaration (*Annex "C"*); **and**
- (j) Section VI (Specifications) and Section VII (Drawings) duly signed or initialed in each and every page by the bidder's authorized representative.
- (k) Original duly signed Omnibus Sworn Statement (OSS) (*Annex D*); **and** if applicable, Original Notarized Secretary's Certificate in case of a corporation, partnership, or cooperative; or Original Special Power of Attorney of all members of the joint venture giving full power and authority to its officer to sign the OSS and do acts to represent the Bidder.

#### Financial Documents

- (l) The prospective bidder's audited financial statements, showing, among others, the prospective bidder's total and current assets and liabilities, stamped "received" by the BIR or its duly accredited and authorized institutions, for



the prospective bidder's total and current assets and liabilities, stamped "received" by the BIR or its duly accredited and authorized institutions, for the preceding calendar year which should not be earlier than two (2) years from the date of bid submission; and

- (m) The prospective bidder's computation of Net Financial Contracting Capacity (*Annex "E"*) (NFCC).

*Class "B" Documents*

- (n) If applicable, duly signed joint venture agreement (JVA) in accordance with RA No. 4566 and its IRR in case the joint venture is already in existence;  
or  
duly notarized statements from all the potential joint venture partners stating that they will enter into and abide by the provisions of the JVA in the instance that the bid is successful.

**II. FINANCIAL COMPONENT ENVELOPE**

- (o) Original of duly signed and accomplished Financial Bid Form; and

Other documentary requirements under RA No. 9184

- (p) Original of duly signed Bid Prices in the Bill of Quantities;

**LIST OF ALL ON-GOING GOVERNMENT & PRIVATE CONTRACTS INCLUDING CONTRACTS AWARDED BUT NOT YET STARTED**

Business Name:

Business Address:

Name of Project / Project Cost	Owner's Name b. Address c. Telephone Nos.	Nature of Work	Bidder's Role		a. Date Awarded b. Date Started c. Date Completion	% of Accomplishment		Value of Outstanding Works / Undelivered Portion
			Description	%		Planned	Actual	
<u>Government:</u>								

Submitted by:

Designation:

Date:

(Printed Name & Signature)

**SINGLE LARGEST COMPLETED CONTRACT**

WHICH IS SIMILAR TO THE CONTRACT TO BE BID

Business Name:			
Business Address:			
Name of Contract	a. Owner' Name	Nature of Item/Service	a. Date Awarded
	b. Address		b. Contract Effectivity
	c. Telephone Nos.		c. Date Completed
<p>Note: This statement shall be supported with:</p> <ol style="list-style-type: none"> <li>1. Contract</li> <li>2. Certificate of Final Acceptance issued by the owner or the Constructors Performance Evaluation System (CPES)</li> </ol> <p>Final rating showing at least a "Satisfactory" rating.</p>			
<p>Note: The Single Largest Completed Contract shall be completed within the last five (5) years from the date of submission and receipt of bids, that is similar to the contract to be bid, the amount of which shall be at least fifty percent (50%) of the ABC.</p>			
Submitted by:			
Designation:		(Printed Name & Signature)	
Date:			

**BID SECURING DECLARATION FORM**

REPUBLIC OF THE PHILIPPINES)

CITY OF \_\_\_\_\_) S.S.

X-----X

**BID SECURING DECLARATION**

**Invitation to Bid:** *[Insert Reference number]*

To: *[Insert name and address of the Procuring Entity]*

I/We<sup>1</sup>, the undersigned, declare that:

1. I/We understand that, according to your conditions, bids must be supported by a Bid Security, which may be in the form of a Bid-Securing Declaration.
2. I/We accept that: (a) I/we will be automatically disqualified from bidding for any contract with any procuring entity for a period of two (2) years upon receipt of your Blacklisting order; and, (b) I/we will pay the applicable fine provided under Section 6 of the Guidelines on the Use of Bid Securing Declaration, within fifteen (15) days from receipt of the written demand by the procuring entity for the commission of acts resulting to the enforcement of the bid securing declaration under Sections 23.1(b), 34.2, 40.1 and 69.1, except 69.1(f), of the IRR of RA 9184; without prejudice to other legal action the government may undertake.
3. I/We understand that this Bid Securing Declaration shall cease to be valid on the following circumstances:
  - (a) Upon expiration of the bid validity period, or any extension thereof pursuant to your request;
  - (b) I am/we are declared ineligible or post-disqualified upon receipt of your notice to such effect, and (i) I/we failed to timely file a request for reconsideration or (ii) I/we filed a waiver to avail of said right;

<sup>1</sup> Select one and delete the other. Adopt the same instruction for similar terms throughout the document.

(c) I am/we are declared the bidder with the Lowest Calculated Responsive Bid, and I/we have furnished the performance security and signed the Contract.

IN WITNESS WHEREOF, I/We have hereunto set my/our hand/s this \_\_\_\_ day of [month] [year] at [place of execution].

[Insert NAME OF BIDDER'S AUTHORIZED  
REPRESENTATIVE]

[Insert Signatory's Legal Capacity]

Affiant

**SUBSCRIBED AND SWORN** to before me this \_\_\_\_ day of [month] [year] at [place of execution], Philippines. Affiant/s is/are personally known to me and was/were identified by me through competent evidence of identity as defined in the 2004 Rules on Notarial Practice (A.M. No. 02-8-13-SC). Affiant/s exhibited to me his/her [insert type of government identification card used], with his/her photograph and signature appearing thereon, with no. \_\_\_\_\_ and his/her Community Tax Certificate No. \_\_\_\_\_ issued on \_\_\_\_ at \_\_\_\_\_.

Witness my hand and seal this \_\_\_\_ day of [month] [year].

**NAME OF NOTARY PUBLIC**

Serial No. of Commission \_\_\_\_\_

Notary Public for \_\_\_\_\_ until \_\_\_\_\_

Roll of Attorneys No. \_\_\_\_\_

PTR No. \_\_\_\_\_ [date issued], [place issued]

IBP No. \_\_\_\_\_ [date issued], [place issued]

Doc. No. \_\_\_\_\_

Page No. \_\_\_\_\_

Book No. \_\_\_\_\_

Series of \_\_\_\_\_

***Omnibus Sworn Statement (Revised)***  
*[shall be submitted with the Bid]*

---

REPUBLIC OF THE PHILIPPINES )  
 CITY/MUNICIPALITY OF \_\_\_\_\_) S.S.

**AFFIDAVIT**

I, [Name of Affiant], of legal age, [Civil Status], [Nationality], and residing at [Address of Affiant], after having been duly sworn in accordance with law, do hereby depose and state that:

1. *[Select one, delete the other:]*

*[If a sole proprietorship:]* I am the sole proprietor or authorized representative of [Name of Bidder] with office address at [address of Bidder];

*[If a partnership, corporation, cooperative, or joint venture:]* I am the duly authorized and designated representative of [Name of Bidder] with office address at [address of Bidder];

2. *[Select one, delete the other:]*

*[If a sole proprietorship:]* As the owner and sole proprietor, or authorized representative of [Name of Bidder], I have full power and authority to do, execute and perform any and all acts necessary to participate, submit the bid, and to sign and execute the ensuing contract for [Name of the Project] of the [Name of the Procuring Entity], as shown in the attached duly notarized Special Power of Attorney;

*[If a partnership, corporation, cooperative, or joint venture:]* I am granted full power and authority to do, execute and perform any and all acts necessary to participate, submit the bid, and to sign and execute the ensuing contract for [Name of the Project] of the [Name of the Procuring Entity], as shown in the attached [state title of attached document showing proof of authorization (e.g., duly notarized Secretary's Certificate, Board/Partnership Resolution, or Special Power of Attorney, whichever is applicable)];

3. [Name of Bidder] is not "blacklisted" or barred from bidding by the Government of the Philippines or any of its agencies, offices, corporations, or Local Government Units, foreign government/foreign or international financing institution whose blacklisting rules have been recognized by the Government Procurement Policy Board, **by itself or by relation, membership, association, affiliation, or controlling interest with another blacklisted person or entity as defined and provided for in the Uniform Guidelines on Blacklisting:**

4. Each of the documents submitted in satisfaction of the bidding requirements is an authentic copy of the original, complete, and all statements and information provided therein are true and correct;

5. [Name of Bidder] is authorizing the Head of the Procuring Entity or its duly authorized representative(s) to verify all the documents submitted;

6. *[Select one, delete the rest:]*

*[If a sole proprietorship:]* The owner or sole proprietor is not related to the Head of the Procuring Entity, members of the Bids and Awards Committee (BAC), the Technical Working Group, and the BAC Secretariat, the head of the Project Management Office or the end-user unit, and the project consultants by consanguinity or affinity up to the third civil degree;

*[If a partnership or cooperative:]* None of the officers and members of *[Name of Bidder]* is related to the Head of the Procuring Entity, members of the Bids and Awards Committee (BAC), the Technical Working Group, and the BAC Secretariat, the head of the Project Management Office or the end-user unit, and the project consultants by consanguinity or affinity up to the third civil degree;

*[If a corporation or joint venture:]* None of the officers, directors, and controlling stockholders of *[Name of Bidder]* is related to the Head of the Procuring Entity, members of the Bids and Awards Committee (BAC), the Technical Working Group, and the BAC Secretariat, the head of the Project Management Office or the end-user unit, and the project consultants by consanguinity or affinity up to the third civil degree;

7. *[Name of Bidder]* complies with existing labor laws and standards; and
8. *[Name of Bidder]* is aware of and has undertaken the responsibilities as a Bidder in compliance with the Philippine Bidding Documents, which includes:
- a. Carefully examining all of the Bidding Documents;
  - b. Acknowledging all conditions, local or otherwise, affecting the implementation of the Contract;
  - c. Making an estimate of the facilities available and needed for the contract to be bid, if any; and
  - d. Inquiring or securing Supplemental/Bid Bulletin(s) issued for the *[Name of the Project]*.
9. *[Name of Bidder]* did not give or pay directly or indirectly, any commission, amount, fee, or any form of consideration, pecuniary or otherwise, to any person or official, personnel or representative of the government in relation to any procurement project or activity.
10. **In case advance payment was made or given, failure to perform or deliver any of the obligations and undertakings in the contract shall be sufficient grounds to constitute criminal liability for Swindling (Estafa) or the commission of fraud with unfaithfulness or abuse of confidence through misappropriating or converting any payment received by a person or entity under an obligation involving the duty to deliver certain goods or services, to the prejudice of the public and the government of the Philippines pursuant to Article 315 of Act No. 3815 s. 1930, as amended, or the Revised Penal Code.**

IN WITNESS WHEREOF, I have hereunto set my hand this\_\_day of\_\_\_\_, 20\_\_at  
\_\_\_\_\_, Philippines.

*[Insert NAME OF BIDDER OR ITS AUTHORIZED  
REPRESENTATIVE]*

*[Insert signatory's legal capacity]*

Affiant

**[Jurat]**

*[Format shall be based on the latest Rules on Notarial Practice]*



## PHILIPPINE INTERNATIONAL CONVENTION CENTER

Name of the Project: **SUPPLY OF LABOR AND MATERIALS FOR THE REPLACEMENT BULLET RESISTANT GLASS DOORS OF HEROES ROOM**

## FINANCIAL DOCUMENTS FOR ELIGIBILITY CHECK

- A. Summary of the Applicant Supplier's/Distributor's/Manufacturer's assets and liabilities on the basis of the attached Income Tax Return and Audited Financial Statement, stamped "RECEIVED" by the Bureau of Internal Revenue or BIR authorized collecting agent, for the immediately preceding year and a certified copy of Schedule of Fixed Assets particularly the list of construction equipment.

		Year 20
1.	Total Assets	
2.	Current Assets	
3.	Total Liabilities	
4.	Current Liabilities	
5.	Net Worth (1-3)	
6.	Net Working Capital (2-4)	
7.	Value of all outstanding or uncompleted portions of the project under ongoing contracts, including awarded contracts yet to be started coinciding with contract to be bid.	

- B. The Net Financial Contracting Capacity (NFCC) based on the above data is computed as follows:

NFCC = [(Current assets minus current liabilities) (15)] minus value of all outstanding or uncompleted portions of the project under ongoing contracts, including awarded contracts yet to be started coinciding with contract to be bid.

NFCC = P \_\_\_\_\_

The values of the bidder's current assets and current liabilities shall be based on the data submitted to the BIR.

or

A committed Line of Credit, in an amount to at least ten percent (10%) of the ABC, issued by a Universal of Commercial Bank.

Submitted by:

\_\_\_\_\_  
Name of Supplier / Distributor / Manufacturer

\_\_\_\_\_  
Signature of Authorized Representative

Date: \_\_\_\_\_

Note:

1. If Partnership or Joint Venture, each Partner or Member Firm of Joint Venture shall submit the above requirements.

## BID FORM

Date: \_\_\_\_\_

Project Identification No: \_\_\_\_\_

To: *[name and address of Procuring Entity]*

Having examined the Philippine Bidding Documents (PBDs) including the Supplemental or Bid Bulletin Numbers *[insert numbers]*, the receipt of which is hereby duly acknowledged, we, the undersigned, declare that:

- a. We have no reservation to the PBDs, including the Supplemental or Bid Bulletins, for the Procurement Project: Supply of Labor and Materials for the Replacement of Bullet Resistant Glass Doors of Heroes Room
- b. We offer to execute the Works for this Contract in accordance with the PBDs;
- c. The total price of our Bid in words and figures, excluding any discounts offered below is:  
\_\_\_\_\_
- d. The discounts offered and the methodology for their application are: *[insert information]*;
- e. The total bid price includes the cost of all taxes, such as, but not limited to: *[specify the applicable taxes, e.g. (i) value added tax (VAT), (ii) income tax, (iii) local taxes, and (iv) other fiscal levies and duties]*, which are itemized herein and reflected in the detailed estimates,
- f. Our Bid shall be valid within the a period stated in the PBDs, and it shall remain binding upon us at any time before the expiration of that period;
- g. If our Bid is accepted, we commit to obtain a Performance Security in the amount of *[insert percentage amount]* percent of the Contract Price for the due performance of the Contract, or a Performance Securing Declaration in lieu of the allowable forms of Performance Security, subject to the terms and conditions of issued GPPB guidelines<sup>12</sup> for this purpose;
- h. We are not participating, as Bidders, in more than one Bid in this bidding process, other than alternative offers in accordance with the Bidding Documents;
- i. We understand that this Bid, together with your written acceptance thereof included in your notification of award, shall constitute a binding contract between us, until a formal Contract is prepared and executed; and
- j. We understand that you are not bound to accept the Lowest Calculated Bid or any other Bid that you may receive.
- k. We likewise certify/confirm that the undersigned, is the duly authorized representative of the bidder, and granted full power and authority to do, execute

<sup>12</sup> currently based on GPPB Resolution No. 09-2020

and perform any and all acts necessary to participate, submit the bid, and to sign and execute the ensuing contract for the [Name of Project] of the [Name of the Procuring Entity].

- i. We acknowledge that failure to sign each and every page of this Bid Form, including the Bill of Quantities, shall be a ground for the rejection of our bid.

Name: \_\_\_\_\_

Legal Capacity: \_\_\_\_\_

Signature: \_\_\_\_\_

Duly authorized to sign the Bid for and behalf of: \_\_\_\_\_

Date: \_\_\_\_\_